



Cisco Model DPC3827 and EPC3827 DOCSIS 3.0 8x4 Wireless Residential Gateway User Guide





In This Document

■ IMPORTANT SAFETY INSTRUCTIONS	ii
■ Introduction.....	12
■ What's In the Carton?.....	14
■ Front Panel Description	15
■ Back Panel Description	16
■ What Are the System Requirements for Internet Service?.....	18
■ How Do I Subscribe to High-Speed Internet Service?.....	19
■ Where Is the Best Location for My DOCSIS Residential Gateway?	20
■ How Do I Mount the Modem on a Wall? (Optional).....	21
■ How Do I Connect My Gateway for Internet Service?.....	24
■ How Do I Configure My DOCSIS Residential Gateway?	26
■ Control Access to the Gateway	46
■ Manage the Gateway.....	56
■ Monitor Gateway Status	65
■ Configure Wireless Settings	81
■ Configure Applications and Gaming.....	93
■ Having Difficulty?	100
■ Tips for Improved Performance	105
■ Front Panel LED Status Indicator Functions.....	106
■ Notices.....	109

IMPORTANT SAFETY INSTRUCTIONS

Notice to Installers

The servicing instructions in this notice are for use by qualified service personnel only. To reduce the risk of electric shock, do not perform any servicing other than that contained in the operating instructions, unless you are qualified to do so.

<p>Note to System Installer</p> <p>For this apparatus, the coaxial cable shield/ screen shall be grounded as close as practical to the point of entry of the cable into the building. For products sold in the US and Canada, this reminder is provided to call the system installer's attention to Article 820-93 and Article 820-100 of the NEC (or Canadian Electrical Code Part 1), which provides guidelines for proper grounding of the coaxial cable shield.</p>	<div style="text-align: center;">  <table border="1" style="margin: 0 auto;"> <tr><td>CAUTION</td></tr> <tr><td>RISK OF ELECTRIC SHOCK DO NOT OPEN</td></tr> <tr><td>AVIS</td></tr> <tr><td>RISQUE DE CHOC ÉLECTRIQUE NE PAS OUVRIR</td></tr> </table>  </div> <p>CAUTION: To reduce the risk of electric shock, do not remove cover (or back). No user-serviceable parts inside. Refer servicing to qualified service personnel.</p> <p>WARNING TO PREVENT FIRE OR ELECTRIC SHOCK, DO NOT EXPOSE THIS UNIT TO RAIN OR MOISTURE.</p> <div style="text-align: center;">  </div> <p>This symbol is intended to alert you of the presence of important operating and maintenance (servicing) instructions in the literature accompanying this product.</p>	CAUTION	RISK OF ELECTRIC SHOCK DO NOT OPEN	AVIS	RISQUE DE CHOC ÉLECTRIQUE NE PAS OUVRIR
CAUTION					
RISK OF ELECTRIC SHOCK DO NOT OPEN					
AVIS					
RISQUE DE CHOC ÉLECTRIQUE NE PAS OUVRIR					
<div style="text-align: center;">  </div> <p>This symbol is intended to alert you that uninsulated voltage within this product may have sufficient magnitude to cause electric shock. Therefore, it is dangerous to make any kind of contact with any inside part of this product.</p>					

Notice à l'attention des installateurs de réseaux câblés

Les instructions relatives aux interventions d'entretien, fournies dans la présente notice, s'adressent exclusivement au personnel technique qualifié. Pour réduire les risques de chocs électriques, n'effectuer aucune intervention autre que celles décrites dans le mode d'emploi et les instructions relatives au fonctionnement, à moins que vous ne soyez qualifié pour ce faire.

<p>Remarque à l'attention de l'installateur du système</p> <p>Avec cet appareil, le blindage/écran du câble coaxial doit être mis à la terre aussi près que possible du point d'entrée du câble dans le bâtiment. En ce qui concerne les produits vendus aux États-Unis et au Canada, ce rappel est fourni pour attirer l'attention de l'installateur sur les articles 820-93 et 820-100 du Code national de l'électricité (ou Code de l'électricité canadien, Partie 1) qui fournissent des lignes directrices concernant la mise à la terre correcte du blindage (écran) du câble coaxial.</p>	<div style="text-align: center;">  <table border="1" style="margin: 0 auto;"> <tr><td>CAUTION</td></tr> <tr><td>RISK OF ELECTRIC SHOCK DO NOT OPEN</td></tr> <tr><td>ATTENTION</td></tr> <tr><td>DANGER ÉLECTRIQUE NE PAS OUVRIR</td></tr> </table>  </div> <p>ATTENTION : Pour réduire les risques de chocs électriques, ne pas enlever le couvercle (ou le panneau arrière). Ne contient aucune pièce réparable par l'utilisateur. Confier les interventions aux techniciens d'entretien qualifiés.</p> <p>AVERTISSEMENT POUR ÉVITER LES INCENDIES OU LES CHOC ÉLECTRIQUES, NE PAS EXPOSER L'APPAREIL À LA PLUIE OU À L'HUMIDITÉ.</p> <div style="text-align: center;">  </div> <p>Ce symbole a pour but de vous prévenir de la présence d'instructions importantes relatives au fonctionnement ou à l'entretien (et aux réparations) dans la documentation accompagnant ce produit.</p>	CAUTION	RISK OF ELECTRIC SHOCK DO NOT OPEN	ATTENTION	DANGER ÉLECTRIQUE NE PAS OUVRIR
CAUTION					
RISK OF ELECTRIC SHOCK DO NOT OPEN					
ATTENTION					
DANGER ÉLECTRIQUE NE PAS OUVRIR					
<div style="text-align: center;">  </div> <p>Ce symbole a pour but de vous prévenir que des tensions électriques non isolées existent à l'intérieur de ce produit, pouvant être d'une intensité suffisante pour causer des chocs électriques. Il est donc dangereux d'établir un contact quelconque avec l'une des pièces comprises à l'intérieur de ce produit.</p>					

Mitteilung für CATV-Techniker

Die in dieser Mitteilung aufgeführten Wartungsanweisungen sind ausschließlich für qualifiziertes Fachpersonal bestimmt. Um die Gefahr eines elektrischen Schlags zu reduzieren, sollten Sie keine Wartungsarbeiten durchführen, die nicht ausdrücklich in der Bedienungsanleitung aufgeführt sind, außer Sie sind zur Durchführung solcher Arbeiten qualifiziert.

<p>Mitteilung an den Systemtechniker</p> <p>Für dieses Gerät muss der Koaxialkabelschutz/ Schirm so nahe wie möglich am Eintrittspunkt des Kabels in das Gebäude geerdet werden. Dieser Erinnerungshinweis liegt den in den USA oder Kanada verkauften Produkten bei. Er soll den Systemtechniker auf Paragraph 820-93 und Paragraph 820-100 der US-Elektrovorschrift NEC (oder der kanadischen Elektrovorschrift Canadian Electrical Code Teil 1) aufmerksam machen, in denen die Richtlinien für die ordnungsgemäße Erdung des Koaxialkabelschirms festgehalten sind.</p>	
 <p>Dieses Symbol weist den Benutzer auf das Vorhandensein von nicht isolierten gefährlichen Spannungen im Gerät hin, die Stromschläge verursachen können. Ein Kontakt mit den internen Teilen dieses Produktes ist mit Gefahren verbunden.</p>	<p>ACHTUNG: Zur Vermeidung eines Stromschlags darf die Abdeckung (bzw. die Geräterückwand) nicht entfernt werden. Das Gerät enthält keine vom Benutzer wartbaren Teile. Wartungsarbeiten dürfen nur von qualifiziertem Fachpersonal durchgeführt werden.</p> <p>WARNUNG</p> <p>DAS GERÄT NICHT REGEN ODER FEUCHTIGKEIT AUSSETZEN, UM STROMSCHLAG ODER DURCH EINEN KURZSCHLUSS VERURSACHTEN BRAND ZU VERMEIDEN.</p>  <p>Dieses Symbol weist den Benutzer darauf hin, dass die mit diesem Produkt gelieferte Dokumentation wichtige Betriebs- und Wartungsanweisungen für das Gerät enthält.</p>

Aviso a los instaladores de sistemas CATV

Las instrucciones de reparación contenidas en el presente aviso son para uso exclusivo por parte de personal de mantenimiento cualificado. Con el fin de reducir el riesgo de descarga eléctrica, no realice ninguna otra operación de reparación distinta a las contenidas en las instrucciones de funcionamiento, a menos que posea la cualificación necesaria para hacerlo.

<p>Nota para el instalador del sistema</p> <p>En lo que se refiere a este aparato, el blindaje del cable coaxial debe conectarse a tierra lo más cerca posible al punto por el cual el cable entra en el edificio. En el caso de los productos vendidos en los EE. UU. y Canadá, el presente aviso se suministra para llamar la atención del instalador del sistema sobre los Artículos 820-93 y 820-100 del NEC (o Código Eléctrico de Canadá, Parte 1), que proporcionan directrices para una correcta conexión a tierra del blindaje del cable coaxial.</p>	
 <p>Este símbolo tiene como fin advertirle de que una tensión sin aislamiento en el interior de este producto podría ser de una magnitud suficiente como para provocar una descarga eléctrica. Por consiguiente, resulta peligroso realizar cualquier tipo de contacto con alguno de los componentes internos de este producto.</p>	<p>ATENCIÓN: con el fin de reducir el riesgo de descarga eléctrica, no retire la tapa (ni la parte posterior). No existen en el interior componentes que puedan ser reparados por el usuario. Encargue su revisión a personal de mantenimiento cualificado.</p> <p>ADVERTENCIA</p> <p>PARA EVITAR EL RIESGO DE INCENDIO O DESCARGA ELÉCTRICA, NO EXPONGA LA UNIDAD A LA LLUVIA O A LA HUMEDAD.</p>  <p>Este símbolo tiene como fin alertarle de la presencia de importantes instrucciones de operación y mantenimiento (revisión) contenidas en la literatura que acompaña al producto.</p>

20080814_Installer820_Intl

IMPORTANT SAFETY INSTRUCTIONS

- 1) Read these instructions.
- 2) Keep these instructions.
- 3) Heed all warnings.

- 4) Follow all instructions.
- 5) Do not use this apparatus near water.
- 6) Clean only with dry cloth.
- 7) Do not block any ventilation openings. Install in accordance with the manufacturer's instructions.
- 8) Do not install near any heat sources such as radiators, heat registers, stoves, or other apparatus (including amplifiers) that produce heat.
- 9) Do not defeat the safety purpose of the polarized or grounding-type plug. A polarized plug has two blades with one wider than the other. A grounding-type plug has two blades and a third grounding prong. The wide blade or the third prong are provided for your safety. If the provided plug does not fit into your outlet, consult an electrician for replacement of the obsolete outlet.
- 10) Protect the power cord from being walked on or pinched particularly at plugs, convenience receptacles, and the point where they exit from the apparatus.
- 11) Only use attachments/accessories specified by the manufacturer.
- 12) Use only with the cart, stand, tripod, bracket, or table specified by the manufacturer, or sold with the apparatus. When a cart is used, use caution when moving the cart/apparatus combination to avoid injury from tip-over.
- 13) Unplug this apparatus during lightning storms or when unused for long periods of time.
- 14) Refer all servicing to qualified service personnel. Servicing is required when the apparatus has been damaged in any way, such as a power-supply cord or plug is damaged, liquid has been spilled or objects have fallen into the apparatus, the apparatus has been exposed to rain or moisture, does not operate normally, or has been dropped.



Power Source Warning

A label on this product indicates the correct power source for this product. Operate this product only from an electrical outlet with the voltage and frequency indicated on the product label. If you are uncertain of the type of power supply to your home or business, consult your service provider or your local power company.

The AC inlet on the unit must remain accessible and operable at all times.

Ground the Product



WARNING: Avoid electric shock and fire hazard! If this product connects to coaxial cable wiring, be sure the cable system is grounded (earthed). Grounding provides some protection against voltage surges and built-up static charges.

Protect the Product from Lightning

In addition to disconnecting the AC power from the wall outlet, disconnect the signal inputs.

Verify the Power Source from the On/Off Power Light

When the on/off power light is not illuminated, the apparatus may still be connected to the power source. The light may go out when the apparatus is turned off, regardless of whether it is still plugged into an AC power source.

Eliminate AC Power/Mains Overloads



WARNING: Avoid electric shock and fire hazard! Do not overload AC power/mains, outlets, extension cords, or integral convenience receptacles. For products that require battery power or other power sources to operate them, refer to the operating instructions for those products.

Provide Ventilation and Select a Location

- Remove all packaging material before applying power to the product.
- Do not place this apparatus on a bed, sofa, rug, or similar surface.
- Do not place this apparatus on an unstable surface.
- Do not install this apparatus in an enclosure, such as a bookcase or rack, unless the installation provides proper ventilation.
- Do not place entertainment devices (such as VCRs or DVDs), lamps, books, vases with liquids, or other objects on top of this product.
- Do not block ventilation openings.

Operating Environment

This product is designed for operation indoors with a temperature range from 32° to 104° F (0° to 40°C). Each product should have adequate spacing on all sides so that the cooling air vents on the chassis are not blocked.

Protect from Exposure to Moisture and Foreign Objects



WARNING: Avoid electric shock and fire hazard! Do not expose this product to dripping or splashing liquids, rain, or moisture. Objects filled with liquids, such as vases, should not be placed on this apparatus.



WARNING: Avoid electric shock and fire hazard! Unplug this product before cleaning. Do not use a liquid cleaner or an aerosol cleaner. Do not use a magnetic/static cleaning device (dust remover) to clean this product.



WARNING: Avoid electric shock and fire hazard! Never push objects through the openings in this product. Foreign objects can cause electrical shorts that can result in electric shock or fire.

Service Warnings



WARNING: Avoid electric shock! Do not open the cover of this product. Opening or removing the cover may expose you to dangerous voltages. If you open the cover, your warranty will be void. This product contains no user-serviceable parts.

Check Product Safety

Upon completion of any service or repairs to this product, the service technician must perform safety checks to determine that this product is in proper operating condition.

Protect the Product When Moving It

Always disconnect the power source when moving the apparatus or connecting or disconnecting cables.

20110316_Modem No Battery_Safety

United States FCC Compliance

This device has been tested and found to comply with the limits for a Class B digital device, pursuant to part 15 of the FCC Rules. These limits are designed to provide reasonable protection against such interference in a residential installation. This equipment generates, uses, and can radiate radio frequency energy. If not installed and used in accordance with the instructions, it may cause harmful interference to radio communications. However, there is no guarantee that interference will not occur in a particular installation. If this equipment does cause harmful interference to radio or television reception, which can be determined by turning the equipment OFF and ON, the user is encouraged to try to correct the interference by one or more of the following measures:

- Reorient or relocate the receiving antenna.
- Increase the separation between the equipment and receiver.
- Connect the equipment into an outlet on a circuit different from that to which the receiver is connected.
- Consult the service provider or an experienced radio/television technician for help.

Any changes or modifications not expressly approved by Cisco Systems, Inc., could void the user's authority to operate the equipment.

The information shown in the FCC Declaration of Conformity paragraph below is a requirement of the FCC and is intended to supply you with information regarding the FCC approval of this device. *The phone numbers listed are for FCC-related questions only and not intended for questions regarding the connection or operation for this device. Please contact your service provider for any questions you may have regarding the operation or installation of this device.*

Declaration of Conformity

This device complies with Part 15 of FCC Rules. Operation is subject to the following two conditions: 1) the device may not cause harmful interference, and 2) the device must accept any interference received, including interference that may cause undesired operation.

DOCSIS Residential Gateway Model(s): DPC3827 EPC3827 Manufactured by: Cisco Systems, Inc. 5030 Sugarloaf Parkway Lawrenceville, Georgia 30044 USA Telephone: +1 770 236-1077
--

Canada EMI Regulation

This Class B digital apparatus complies with Canadian ICES-003.

Cet appareil numérique de la class B est conforme à la norme NMB-003 du Canada.

RF Exposure Statements

Note: This transmitter must not be co-located or operated in conjunction with any other antenna or transmitter. This equipment should be installed and operated with a minimum distance of 7.9 inches (20 cm) between the radiator and your body.

US

This system has been evaluated for RF exposure for humans in reference to ANSI C 95.1 (American National Standards Institute) limits. The evaluation was based in accordance with FCC OET Bulletin 65C rev 01.01 in compliance with Part 2.1091 and Part 15.27. The minimum separation distance from the antenna to general bystander is 7.9 inches (20 cm) to maintain compliance.

Canada

This system has been evaluated for RF exposure for humans in reference to Canada Health Code 6 (2009) limits. The evaluation was based on evaluation per RSS-102 Rev 4. The minimum separation distance from the antenna to general bystander is 7.9 inches (20 cm) to maintain compliance.

20100527 FCC DSL_Domestic

Declaration of Conformity with Regard to the EU Directive 1999/5/EC (R&TTE Directive)

This declaration is only valid for configurations (combinations of software, firmware and hardware) supported or provided by Cisco Systems for use within the EU. The use of software or firmware not supported or provided by Cisco Systems may result in the equipment no longer being compliant with the regulatory requirements.

Български [Bulgarian]:	Това оборудване отговаря на съществените изисквания и приложими клаузи на Директива 1999/5/EC.
Česky [Czech]:	Toto zařízení je v souladu se základními požadavky a ostatními odpovídajícími ustanoveními Směrnice 1999/5/EC.
Dansk [Danish]:	Dette udstyr er i overensstemmelse med de væsentlige krav og andre relevante bestemmelser i Direktiv 1999/5/EF.
Deutsch [German]:	Dieses Gerät entspricht den grundlegenden Anforderungen und den weiteren entsprechenden Vorgaben der Richtlinie 1999/5/EU.
Eesti [Estonian]:	See seade vastab direktiivi 1999/5/EU olulistele nõuetele ja teistele asjakohastele sätetele.
English:	This equipment is in compliance with the essential requirements and other relevant provisions of Directive 1999/5/EC.
Español [Spanish]:	Este equipo cumple con los requisitos esenciales así como con otras disposiciones de la Directiva 1999/5/CE.
Ελληνική [Greek]:	Αυτός ο εξοπλισμός είναι σε συμμόρφωση με τις ουσιαστικές απαιτήσεις και άλλες σχετικές διατάξεις της Οδηγίας 1999/5/EC.
Français [French]:	Cet appareil est conforme aux exigences essentielles et aux autres dispositions pertinentes de la Directive 1999/5/EC.
Íslenska [Icelandic]:	Þetta tæki er samkvæmt grunnkröfum og öðrum viðeigandi ákvæðum Tilskipunar 1999/5/EC.
Italiano [Italian]:	Questo apparato è conforme ai requisiti essenziali ed agli altri principi sanciti dalla Direttiva 1999/5/CE.
Latviski [Latvian]:	Šī iekārta atbilst Direktīvas 1999/5/EK būtiskajām prasībām un citiem ar to saistītajiem noteikumiem.
Lietuvių [Lithuanian]:	Šis įrenginys tenkina 1999/5/EB Direktyvos esminius reikalavimus ir kitas šios direktyvos nuostatas.
Nederlands [Dutch]:	Dit apparaat voldoet aan de essentiële eisen en andere van toepassing zijnde bepalingen van de Richtlijn 1999/5/EC.
Malti [Maltese]:	Dan l-apparat huwa konformi mal-ftigiet essenzjali u l-provedimenti l-oħra rilevanti tad-Direttiva 1999/5/EC.
Magyar [Hungarian]:	Ez a készülék teljesíti az alapvető követelményeket és más 1999/5/EK irányelvben meghatározott vonatkozó rendelkezéseket.
Norsk [Norwegian]:	Dette utstyret er i samsvar med de grunnleggende krav og andre relevante bestemmelser i EU-direktiv 1999/5/EF.
Polski [Polish]:	Urządzenie jest zgodne z ogólnymi wymaganiami oraz szczególnymi warunkami określonymi Dyrektywą UE: 1999/5/EC.
Português [Portuguese]:	Este equipamento está em conformidade com os requisitos essenciais e outras provisões relevantes da Directiva 1999/5/EC.
Română [Romanian]:	Acest echipament este în conformitate cu cerințele esențiale și cu alte prevederi relevante ale Directivei 1999/5/EC.
Slovensko [Slovenian]:	Ta naprava je skladna z bistvenimi zahtevami in ostalimi relevantnimi pogoji Direktive 1999/5/EC.
Slovensky [Slovak]:	Toto zariadenie je v zhode so základnými požiadavkami a inými príslušnými nariadeniami direktív: 1999/5/EC.
Suomi [Finnish]:	Tämä laite täyttää direktiivin 1999/5/EY olennaiset vaatimukset ja on siinä asetettujen muiden laitetta koskevien määräysten mukainen.
Svenska [Swedish]:	Denna utrustning är i överensstämmelse med de väsentliga kraven och andra relevanta bestämmelser i Direktiv 1999/5/EC.

Note: The full declaration of conformity for this product can be found at http://www.cisco.com/web/consumer/support/compliance_info.html.

The following standards were applied during the assessment of the product against the requirements of the Directive 1999/5/EC:

- Radio: EN 300 328
- EMC: EN 301 489-1 and EN 301 489-17
- Safety: EN 60950 and EN 50385

The CE mark and class-2 identifier are affixed to the product and its packaging. This product conforms to the following European directives:



National Restrictions

This product is for indoor use only.

France

For 2.4 GHz, the output power is restricted to 10 mW EIRP when the product is used outdoors in the band 2454 – 2483.5 MHz. There are no restrictions when used in other parts of the 2.4 GHz band. Check <http://www.arcep.fr/> for more details.

Pour la bande 2,4 GHz, la puissance est limitée à 10 mW en p.i.r.e. pour les équipements utilisés en extérieur dans la bande 2454 - 2483,5 MHz. Il n'y a pas de restrictions pour des utilisations dans d'autres parties de la bande 2,4 GHz. Consultez <http://www.arcep.fr/> pour de plus amples détails.

Italy

This product meets the National Radio Interface and the requirements specified in the National Frequency Allocation Table for Italy. Unless this wireless LAN product is operating within the boundaries of the owner's property, its use requires a “general authorization.” Please check <http://www.comunicazioni.it/it/> for more details.

Questo prodotto è conforme alle specifiche di Interfaccia Radio Nazionali e rispetta il Piano Nazionale di ripartizione delle frequenze in Italia. Se non viene installato all'interno del proprio fondo, l'utilizzo di prodotti Wireless LAN richiede una “Autorizzazione Generale”. Consultare <http://www.comunicazioni.it/it/> per maggiori dettagli.

Latvia

The outdoor usage of the 2.4 GHz band requires an authorization from the Electronic Communications Office. Please check <http://www.esd.lv> for more details.

2,4 GHz frekvenču joslas izmantošanai ārpus telpām nepieciešama atļauja no Elektronisko sakaru direkcijas. Vairāk informācijas: <http://www.esd.lv>.

Note: The regulatory limits for maximum output power are specified in EIRP. The EIRP level of a device can be calculated by adding the gain of the antenna used (specified in dBi) to the output power available at the connector (specified in dBm).

Antennas

Use only the antenna supplied with the product.

20110311_CE_Gateway

Introduction

Welcome to the exciting world of high-speed Internet service. Your new Cisco® Model DPC3827 DOCSIS® 8x4 3.0 or EPC3827 EuroDOCSIS™ Wireless Residential Gateway is a high-performance home gateway that combines a cable modem, router, wireless access point, and MoCA™ in a single device for both the home and small office. The DPC3827 and EPC3827 residential gateway delivers data and wired (Ethernet) or wireless gateway capabilities to connect a variety of devices in the home or small office and support high-speed data access, all in one device. With a DPC3827 or EPC3827 residential gateway, your Internet enjoyment, home and business communications, and personal productivity will surely soar.

This guide provides procedures and recommendations for placing, installing, configuring, operating, and troubleshooting your DPC3827 and EPC3827 residential gateway for high-speed Internet service for your home or office. Refer to the appropriate section in this guide for the specific information you need for your situation. Contact your service provider for more information about subscribing to these services.

Benefits and Features

Your new DPC3827 and EPC3827 residential gateway offers the following outstanding benefits and features:

DOCSIS

- Eight bonded downstream channels with a total throughput in excess of 300 Mbps
- Compliant with DOCSIS 3.0, 2.0, 1.1, and 1.0 standards to deliver high-end performance and reliability
- Enhanced packet processing technology to maximize performance

Connections

- MoCA 1.1 networking over coaxial cable in the home
- Four 10/100/1000BASE-T Ethernet ports to provide wired connectivity
- High-performance broadband Internet connectivity to energize your online experience
- 802.11n, Single Band 2.4 GHz 2x2 Wireless Access Point (WAP) with four Service Set Identifiers (SSIDs) or optional Dual-Band non-concurrent radio
- WPS, including a push-button switch to activate WPS for simplified and secure wireless setup
- USB host port (optional)

Design and Function

- Simplified self-install using intuitive webpage design for user-friendly setup and management
- DOCSIS-5 compliant LED labeling and behavior with dual-color LEDs provides a user- and technician-friendly method to check operational status and act as a troubleshooting tool
- TR-068 compliant color-coded interface ports and corresponding cables simplify installation and setup
- Attractive, compact design and versatile orientation to stand vertically, lie flat on the desktop or shelf, or mount easily on a wall

Management

- TR-069 (optional) along with XML schema and/or SNMP Provisioning and Management of the WAN interface and gateway functionality
- User-configurable Parental Control blocks access to undesirable Internet sites
- Advanced firewall technology deters hackers and protects the home network from unauthorized access
- Allows automatic software upgrades by your service provider
- DOCSIS-compliant secure software downloads

Software and Documentation

- CD-ROM containing user guide

What's In the Carton?

When you receive your wireless residential gateway, you should check the equipment and accessories to verify that each item is in the carton and that each item is undamaged. The carton contains the following items:



One DPC3827 or EPC3827
Residential Gateway



One power adapter (models
requiring external power supply)



One Ethernet cable (CAT5/RJ-45)



One CD-ROM

If any of these items are missing or damaged, please contact your service provider for assistance.

Note: You will need an optional cable signal splitter and additional standard RF coaxial cables if you want to connect a VCR, a Digital Home Communications Terminal (DHCT) or a set-top converter, or a TV to the same cable connection as your wireless residential gateway.

Front Panel Description

The front panel of your residential gateway provides LED status indicators that indicate how well and at what state your residential gateway is operating. See *Front Panel LED Status Indicator Functions* (on page 106), for more information on front panel LED status indicator functions.

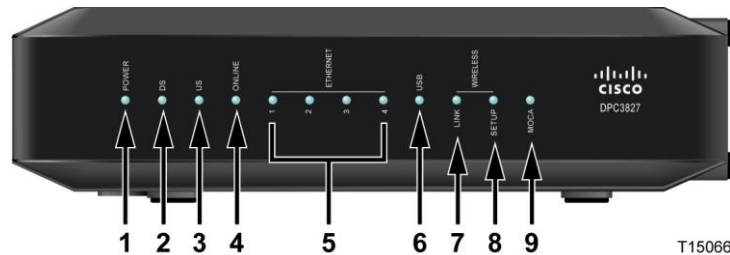

Model DPC3827 shown here

- 1 **POWER**—ON, power is applied to the wireless residential gateway
- 2 **DS**—ON, the wireless residential gateway is receiving data from the cable network
- 3 **US**—On, the wireless residential gateway is sending data to the cable network
- 4 **ONLINE**—ON, the wireless residential gateway is registered on the network and fully operational
- 5 **ETHERNET 1 - 4**—ON, a device is connected to one of the Ethernet ports. BLINKING indicates that data is being transferred over the Ethernet connection
- 6 **USB**—ON, a device is connected to the USB port. BLINKING indicates that data is being transferred over the USB connection
- 7 **WIRELESS LINK**—ON, the Wireless Access Point is operational. BLINKING indicates that data is being transferred over the wireless connection. OFF indicates that the wireless access point has been disabled by the user
- 8 **WIRELESS SETUP**—OFF (normal condition) wireless setup is not active. BLINKING indicates the user has activated wireless setup to add new wireless clients on the wireless network
- 9 **MoCA**—ON, the MoCA is operational. BLINKING indicates that data is being transferred over the MoCA connection. OFF indicates that the MoCA has been disabled by the user or that the device is not connected to the MoCA network

Back Panel Description

The following illustrations show the description and function of the back panel components on the Cisco DPC3827 residential gateway.

Model DPC3827

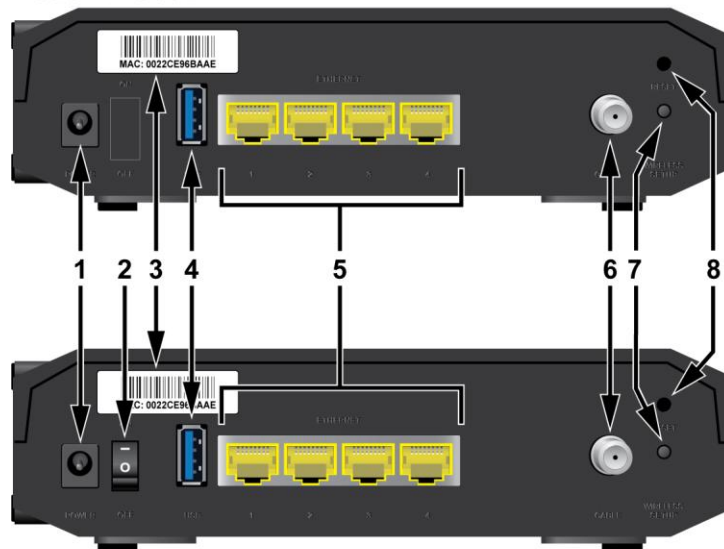

Model EPC3827

T15086

- 1 **POWER** – Connects the residential gateway to the AC power adapter that is provided with your residential gateway



CAUTION:

Avoid damage to your equipment. Only use the power supply that is provided with your residential gateway.

- 2 **ON/OFF SWITCH (European models only)** – Allows you to power off the residential gateway without removing the power cord
- 3 **MAC ADDRESS LABEL** – Displays the MAC address of the residential gateway
- 4 **USB** – Connects to selected client devices
- 5 **ETHERNET** – Four RJ-45 Ethernet ports connect to the Ethernet port on your PC or your home network
- 6 **CABLE** – F-connector connects to an active cable signal from your service provider and to a MoCA network, if present
- 7 **WIRELESS SETUP** – Pressing this switch initiates wireless setup. This feature allows the user to add new Wireless Protected Setup (WPS) compliant wireless clients to the home network

- 8 **RESET** – A momentary pressing (1-2 seconds) of this switch reboots the EMTA. Pressing the switch for more than ten seconds first causes a reset-to-factory default of all settings and then reboots the gateway



CAUTION:

The Reset button is for maintenance purposes only. Do not use unless instructed to do so by your cable service provider. Doing so may cause you to lose any cable modem settings you have selected.

What Are the System Requirements for Internet Service?

To ensure that your residential gateway operates efficiently for high-speed Internet service, verify that all of the Internet devices on your system meet or exceed the following minimum hardware and software requirements.

Note: You will also need an active cable input line and an Internet connection.

Minimum System Requirements for a PC

- A PC with a Pentium MMX 133 processor or greater
- 32 MB of RAM
- Web browsing software
- CD-ROM drive

Minimum System Requirements for Macintosh

- MAC OS 7.5 or later
- 32 MB of RAM

System Requirements for an Ethernet Connection

- A PC with Microsoft Windows 2000 operating system (or later) with TCP/IP protocol installed, or an Apple Macintosh computer with TCP/IP protocol installed
- An active 10/100/1000BASE-T Ethernet network interface card (NIC) installed

How Do I Subscribe to High-Speed Internet Service?

Before you can use your residential gateway, you need to have a high-speed Internet access account. If you do not have a high-speed Internet access account, you need to set up an account with your local service provider. Choose one of the options in this section.

I Do Not Have a High-Speed Internet Access Account

If you do *not* have a high-speed Internet access account, your service provider will set up your account and become your Internet Service Provider (ISP). Internet access enables you to send and receive e-mail, access the World Wide Web, and receive other Internet services.

You will need to give your service provider the following information:

- The serial number of the modem
- The Media Access Control (MAC) address of the modem (CM MAC)
- Other MAC address numbers as needed

These numbers appear on a bar code label located on the residential gateway. The serial number consists of a series of alphanumeric characters preceded by **S/N**. The MAC address consists of a series of alphanumeric characters preceded by **CM MAC**. The following illustration shows a sample DPC3827 bar code label.

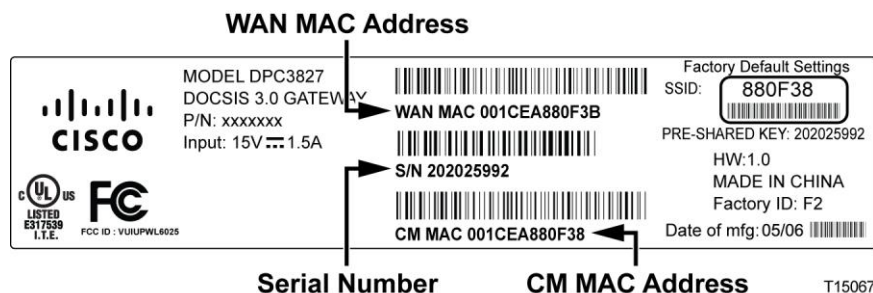

Write down these numbers in the space provided here.

Serial Number _____

MAC Address _____

I Already Have an Existing High-Speed Internet Access Account

If you have an existing high-speed Internet access account, you must give your service provider the serial number and the MAC address of the residential gateway. Refer to the serial number and MAC address information listed previously in this section.

Where Is the Best Location for My DOCSIS Residential Gateway?

The ideal location for your residential gateway is where it has access to outlets and other devices. Think about the layout of your home or office, and consult with your service provider to select the best location for your residential gateway. Read this user guide thoroughly before you decide where to place your residential gateway.

Consider these recommendations:

- Choose a location close to your computer if you will also use the residential gateway for high-speed Internet service.
- Choose a location that is near an existing RF coaxial connection to eliminate the need for an additional RF coaxial outlet.
- Choose a location that is relatively protected from accidental disturbance or harm, such as a closet, basement, or other protected area.
- Choose a location so that there is plenty of room to guide the cables away from the modem without straining or crimping them.
- Airflow around the residential gateway should not be restricted.
- Read this user guide thoroughly before installing the residential gateway.

How Do I Mount the Modem on a Wall? (Optional)

You can mount the residential gateway on a wall using two wall anchors, two screws, and the mounting slots located on the unit. The modem can be mounted vertically or horizontally.

Before You Begin

Before you begin, choose an appropriate mounting place. The wall can be made of cement, wood, or drywall. The mounting location should be free of obstructions on all sides, and the cables should be able to easily reach the residential gateway without strain. Leave sufficient clearance between the bottom of the residential gateway and any flooring or shelving underneath to allow access to cabling. In addition, leave enough slack in all cables so that the residential gateway can be removed for any required maintenance without disconnecting the cables. Also, verify that you have the following items:

- Two wall anchors for #8 x 1-inch screws
- Two #8 x 1-inch pan head sheet metal screws
- Drill with a 3/16-in. wood or masonry bit, as appropriate for the wall composition
- A copy of the wall-mounting illustrations shown on the following pages

How Do I Mount the Modem on a Wall? (Optional)

Mount the modem as shown in one of the following illustrations.

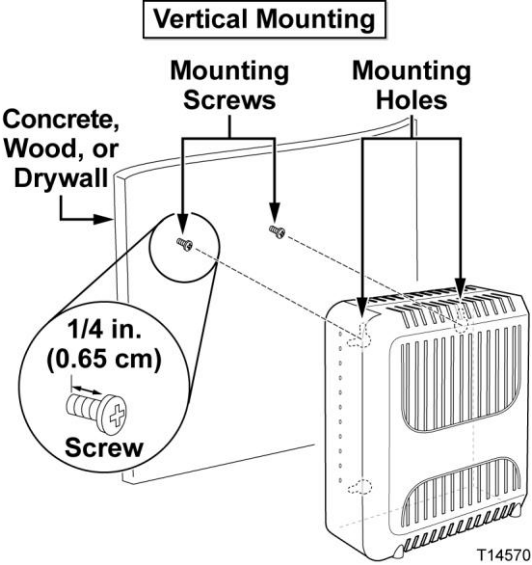
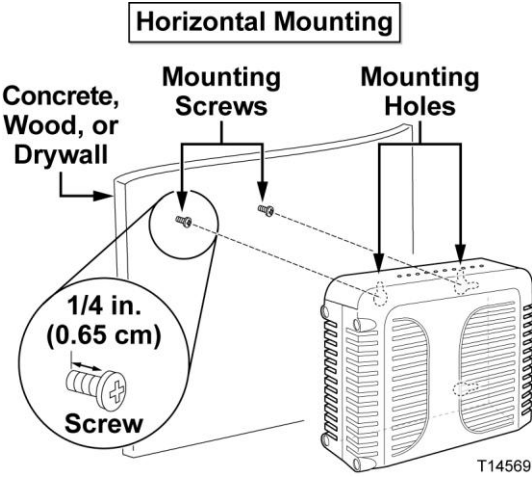

Location and Dimensions of the Wall-Mounting Slots

The following illustration shows the location and dimensions of the wall-mounting slots on the bottom of the modem. Use the information on this page as a guide for mounting your modem to the wall.

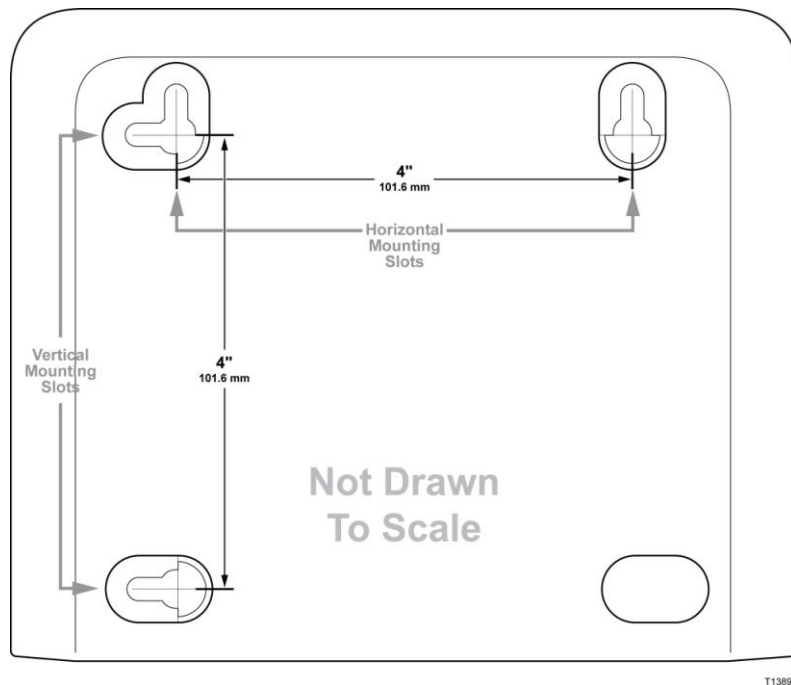

Mounting the Residential Gateway on a Wall

- 1 Using a drill with a 3/16-inch bit, drill two holes at the same height and 4 inches apart.

Note: The preceding graphic illustrates the location of the mounting holes on the back of the residential gateway.

- 2 Are you mounting the residential gateway into a drywall or concrete surface where a wooden stud is available?
 - If **yes**, go to step 3.
 - If **no**, drive the anchor bolts into the wall, and install the mounting screws into the anchor bolts; leave a gap of about 1/4-inch between the screw head and the wall. Then, go to step 4.
- 3 Install the mounting screws into the wall; leave a gap of about 1/4-inch between the screw head and the wall. Then, go to step 4.
- 4 Verify that no cables or wires are connected to the residential gateway.
- 5 Lift the residential gateway into position. Slip the large end of both mounting slots (located in the back of the residential gateway) over the mounting screws, and then slide the residential gateway down until the narrow end of the keyhole slot contacts the screw shaft.

Important: Verify that the mounting screws securely support the residential gateway before you release the unit.

How Do I Connect My Gateway for Internet Service?

You can use your residential gateway to provide Internet access, and you can share that Internet connection with other Internet devices in your home or office. Sharing one connection among many devices is called networking.

Connecting and Installing Internet Devices

Professional installation may be available. Contact your local service provider for further assistance.

To connect devices

The following diagram illustrates one of the various networking options that are available to you.

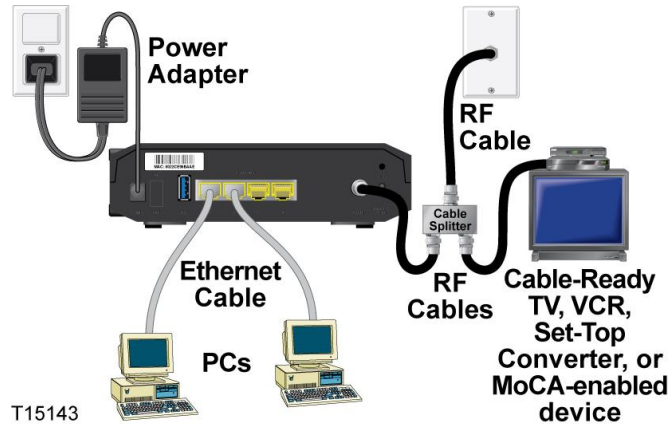

Connecting the Media Gateway for High-Speed Data Service

The following installation procedure ensures proper setup and configuration for the residential gateway.

- 1 Choose an appropriate and safe location to install the residential gateway (close to a power source, an active cable connection, your PC – if using high-speed Internet).



WARNING:

- To avoid personal injury, follow the installation instructions in the exact order shown.
- Wiring and connections must be properly insulated to prevent electrical shock.
- Disconnect power from the residential gateway before attempting to connect to any device.

- 2 Power off your PC and other networking device; then, unplug them from the power source.

- 3 Connect the active RF coaxial cable from your service provider to the coax connector labeled **CABLE** on the back of the residential gateway.

Note: To connect a TV, DHCT, set-top, or VCR from the same cable connection, you will need to install a cable signal splitter (not included). Always check with your service provider before using a splitter as a splitter may degrade the signal.

- 4 Connect your PC to the residential gateway using either of the following methods.

- **Ethernet Connection:** Locate the yellow Ethernet cable. Connect one end of the Ethernet cable to the Ethernet port on your PC, and connect the other end to the yellow **ETHERNET** port on the back of the residential gateway.

Note: To install more Ethernet devices than ports provided on the residential gateway, use an external multi-port Ethernet switch(s).

- **Wireless:** Make sure that your wireless device is powered up. You will need to associate your wireless device with the wireless gateway once the gateway is operational. Follow the directions provided with your wireless device for associating with a wireless access point.

More information about the factory default configuration of your wireless gateway can be found later in this user guide in *Configure Wireless Settings* (on page 81).

- 5 Locate the AC power cord provided with your residential gateway. Insert one end of the power cord into the AC connector on the back of the residential gateway. Then, plug the AC power cord into an AC outlet to power-up the residential gateway. The residential gateway will perform an automatic search to locate and sign on to the broadband data network. This process may take up to 2-5 minutes. The modem will be ready for use when the **POWER**, **DS**, **US**, and **ONLINE** LEDs on the front panel of the residential gateway stop blinking and remain on continuously.
- 6 Plug in and power on your PC and other home network devices. The **LINK** LED on the residential gateway corresponding to the connected devices should be on or blinking.
- 7 Once the residential gateway is online, most Internet devices will have immediate Internet access.

Notes:

- For Internet devices other than PCs, refer to the DHCP or IP Address configuration section of the User Guide or Operations Manual for those devices.
- When using MoCA, we recommend that you install a point of entry filter to contain the MoCA signal within your home network. Contact your service provider for more information about your MoCA network.
- On some occasions, the MoCA signal may affect the operation of other devices connected to your home coax network. Installation of a MoCA (low-pass) filter at the coax input of the affected devices may restore the normal operation.

How Do I Configure My DOCSIS Residential Gateway?

To configure your residential gateway, you must first access the WebWizard configuration pages. This section provides detailed instructions and procedures for accessing the WebWizard pages and for configuring your residential gateway to operate correctly. This section also presents examples and descriptions of each WebWizard configuration page. Use the WebWizard pages to customize your residential gateway to your needs rather than using the default settings. The WebWizard pages in this section are organized in the order shown on the **Setup** page.

Important: The WebWizard pages and the examples shown in this section are for illustration purposes only. Your pages may differ from the pages shown in this guide. The pages shown in this guide also represent the default values for the device.

Note: If you are not familiar with the network configuration procedures detailed in this section, contact your service provider before you attempt to change any of the residential gateway default settings.

Logging in to the Gateway for the First Time

The default configuration of the gateway uses IP address 192.168.0.1. If you have connected the gateway correctly and you have properly configured your computer, use the following steps to log in to the gateway as an administrator.

- 1 On your PC, open the web browser that you prefer to use.

- 2 In the address field, enter the following IP address: **192.168.0.1**. A Status DOCSIS WAN login page similar to the following page opens.

Status

DOCSIS WAN

Log In

User Name:

Password:

About

Model: **Cisco EPC3925**
 Vendor: **Cisco**
 Hardware Revision: **1.0**
 Serial Number: **222596078**
 MAC Address: **00:22:3a:ce:d8:75**
 Bootloader Revision: **2.3.0_R1**
 Current Software Revision: **epc3925-ESIP-16-v302r12911-091029c**
 Firmware Name: **epc3925-ESIP-16-v302r12911-091029c.bin**
 Firmware Build Time: **Oct 29 2009 15:48:04**
 Cable Modem Status: **Operational**

Downstream Channels

Channel	Power Level	Signal to Noise Ratio
Channel 1:	-17.1 dBmv	33.9 dBmv
Channel 2:	0.0 dBmv	0.0 dBmv
Channel 3:	0.0 dBmv	0.0 dBmv
Channel 4:	0.0 dBmv	0.0 dBmv
Channel 5:	0.0 dBmv	0.0 dBmv
Channel 6:	0.0 dBmv	0.0 dBmv
Channel 7:	0.0 dBmv	0.0 dBmv
Channel 8:	0.0 dBmv	0.0 dBmv

Upstream Channels

Channel	Power Level
Channel 1:	41.0 dBmv
Channel 2:	0.0 dBmv
Channel 3:	0.0 dBmv
Channel 4:	0.0 dBmv

[Online Help...](#)

- 3 On the Status DOCSIS WAN page, leave the User Name and Password field blank and click **Log In**. The gateway opens with an Administration Management page in the forefront. You can use the Administration Management page to change your User Name and Password.

At this point you are logged into the gateway. You can select any of the setup and management web pages. However, you were directed to the Administration Management to serve as a reminder to set up a new password.

Important: We highly recommend that you set up a new password to safeguard against the possibility of Internet attacks that look for devices operating with well-known or factory default user names and/or passwords.

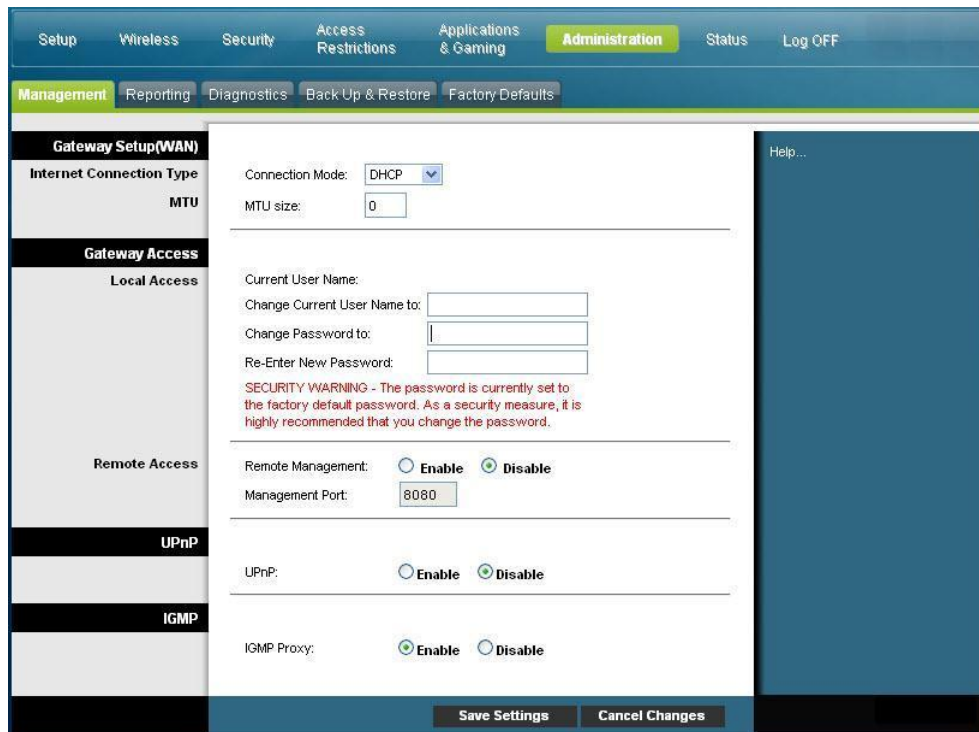

- 4 On the Administration Management page, create a User Name and Password and then click **Save Settings**. Once you save the settings for your User Name and Password on the Administration Management page, the Setup Quick Setup page opens.

Important: You have the option to leave the password field blank (factory default). However, if you do not change your User Name and Password, you will be directed to the Administrative Management page each time you access the gateway. This serves as a reminder to set up your personalized password.

Once you have personalized your Password, subsequent logins will take you directly to the Setup Quick Setup page.

- 5 After you make your selections, click **Save Settings** to apply your changes or **Cancel Changes** to cancel.

Setup > Lan Setup

The Setup Lan Setup page allows you to configure the settings for the Local Area Network (LAN) in your home. These settings include the range of IP addresses that define the LAN itself as well as how the addresses are assigned (automatically by DHCP or manually) as new devices are added to the network.

Important: Unless you are knowledgeable about administering IP addresses, we recommend that you do not change these settings. If you change these values incorrectly, you can lose Internet access.

Select the **Lan Setup** tab to open the Setup Lan Setup page.

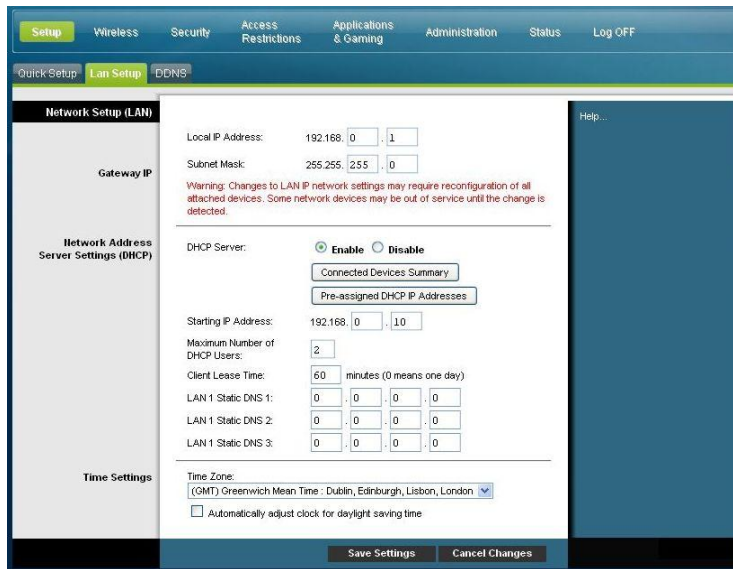

Configuring Your Network Settings

Use the descriptions and instructions in the following table to configure the network settings for your residential gateway. After you make your selections, click **Save Settings** to apply your changes or click **Cancel Changes** to cancel.

Section	Field Description
Network Setup (LAN)	Local IP Address
Gateway IP	The base IP address of the private home LAN. The factory default LAN IP Address is 192.168.0.1.
	Subnet Mask
	The subnet mask for your LAN

Section	Field Description
Network Address Server Settings (DHCP)	DHCP Server

Allows you to enable or disable the DHCP server in the residential gateway. The DHCP server is used to automatically allocate IP addresses to devices as they are attached to your home network.

Connected Devices Summary page

Click **Connected Devices Summary** in the Lan Setup page. The Connected Devices Summary page opens. This page is a pop-up window that displays the MAC Address and IP Address of the devices that are connected to the residential gateway.



Pre-assigned DHCP IP Address page

Click **Pre-assigned DHCP IP Addresses** in the Lan Setup page. The Pre-assigned DHCP IP addresses page opens. This page allows you to assign a specific IP address to a PC or other device when they request an IP address using DHCP. Only addresses within the range of the gateway's DHCP address pool can be reserved with this feature.

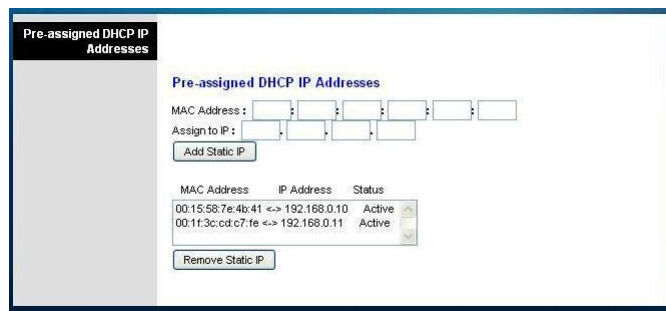

Notes:

- The **Add Static IP** button adds the Static IP address to the list of pre-assigned IP addresses.
- The **Remove Static IP** button removes the Static IP address from the list of pre-assigned IP addresses

Section	Field Description
	<p>Starting IP Address</p> <p>Displays the starting address used by the built-in DHCP server to distribute Private LAN IP addresses. Because the device default IP address of the gateway is 192.168.0.1, the starting IP address must be 192.168.0.2 or greater, but smaller than 192.168.0.253. The default Starting IP Address is 192.168.0.10.</p>
	<p>Maximum Number of DHCP Users</p> <p>Enter the maximum number of users to which the DHCP server can assign IP addresses for use in the LAN. This number cannot be greater than 254 minus the starting IP address described above.</p>
	<p>Client Lease Time</p> <p>The Client Lease Time is the amount of time an IP address is valid. IP address leases are renewed automatically by your PC and other devices that use DHCP to obtain IP addresses. If a lease is allowed to expire, the IP address will be returned to the pool of available IP addresses that can be assigned by the DHCP server as new devices are added to your network. The default is 60 minutes when the gateway is online.</p>
	<p>LAN Static DNS (Domain Name Server) 1-3</p> <p>DNS is used by a PC or other client devices to discover the public IP address associated with a URL or the name-based address of a website. You can manually specify which DNS servers are to be used by devices in your network by entering the IP addresses of those servers in these fields. Otherwise, the gateway will forward the DNCS server information from your service provider automatically. The default is to leave these fields blank.</p>
<p>Time Settings</p>	<p>Time Zone</p> <p>Select the time zone for your location. If your location follows daylight saving time, select Automatically adjust clock for daylight saving time.</p>

Setup > DDNS

Dynamic Domain Name Service (DDNS) provides the residential gateway (that may have a changing IP address) with a host name or URL resolvable by network applications through standard DNS queries. DDNS is useful when you are hosting your own website, FTP server, or other server behind the device. Before using this feature, you need to sign up for DDNS service.

Select the **DDNS** tab to open the Setup DDNS page.

Disabling DDNS (Factory Default Settings)

To disable DDNS, select **Disabled** from the drop-down list and click **Save Settings**.

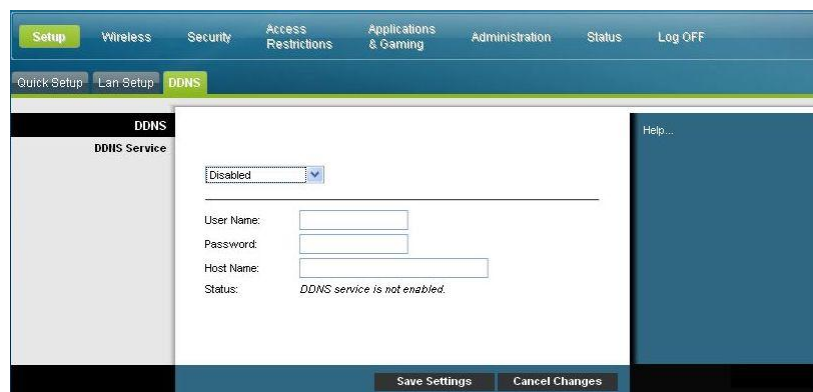

Enabling DDNS

Note: In order to use the DDNS feature, you must first set up an account and establish a URL with www.DynDNS.org. The DDNS feature will not work without a valid account.

To set up a DDNS account, open your browser and enter www.DynDNS.org in the address bar. Follow the instructions on the website to set up an account.

To enable DDNS, follow these steps.

- 1 On the DDNS page, select **www.DynDNS.org** as your DDNS server.

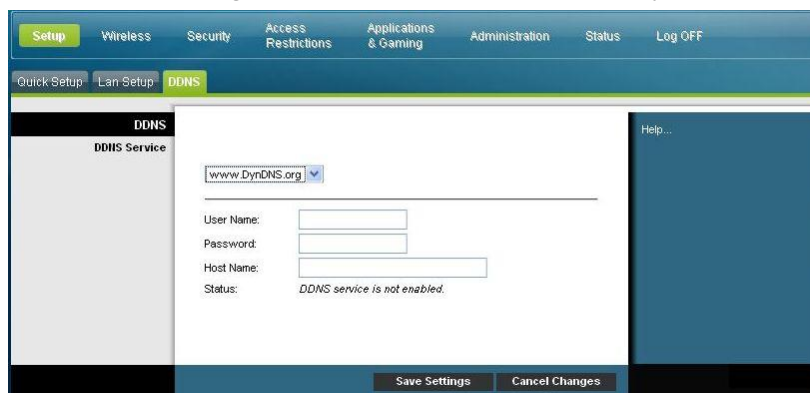

- 2 Configure the following fields:
 - User Name
 - Password
 - Host Name
- 3 Click **Save Settings**. The device will now advise the DDNS service of your current WAN (Internet) IP address whenever this address changes.

Important: The Status area of the window will display the status of the DDNS service connection.

Setup > Wireless QoS

The following illustration is an example of the Wireless QoS (Quality of Service) page.

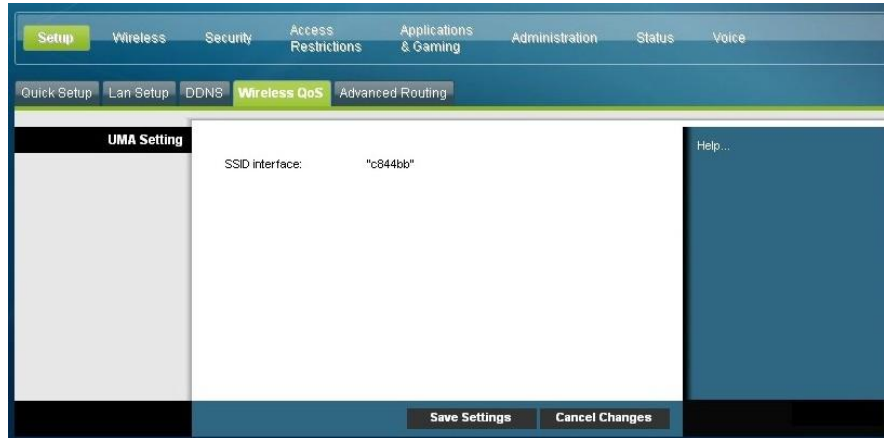

Setup > Advanced Routing

Use this page to set up the advanced routing functions such as enabling or disabling the network address translation (NAT). You can configure the following advanced routing settings for the residential gateway on this page:

- Advanced Routing
- Dynamic Routing
- Routed Subnet Support

Select **Advanced Routing** to open the Setup Advanced Routing page.

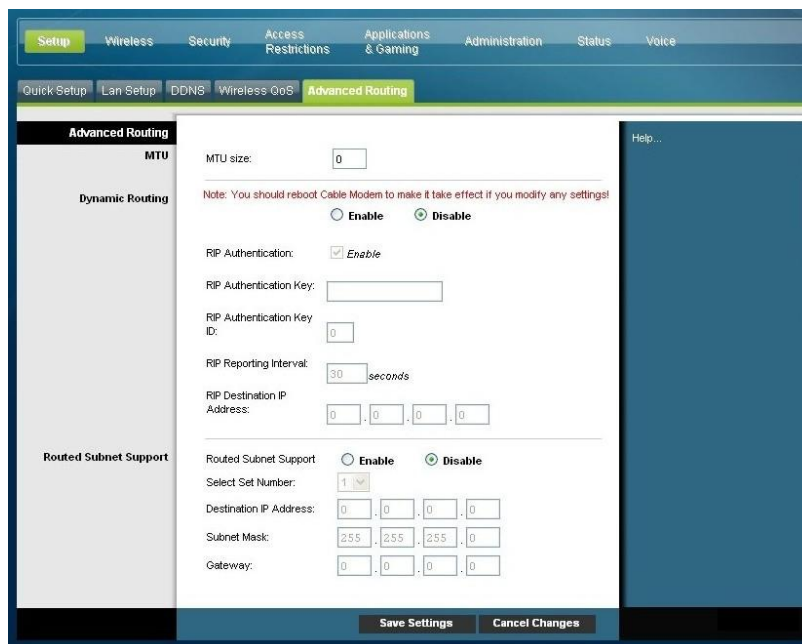

Use the following table to configure the advanced routing settings for the residential gateway. After you make your selections, click **Save Settings** to apply your changes or **Cancel Changes** to cancel.

Section	Field Description
Advanced Routing	MTU Size
MTU	MTU is the Maximum Transmission Unit. The MTU size specifies the largest packet size permitted for Internet transmission. Select Manual if you want to manually enter the largest packet size that will be transmitted. 1500 is the recommended size. You should leave this value in the 1200 to 1500 range. To have the device select the best MTU for your Internet connection, keep the default setting, Auto.
Dynamic Routing	Dynamic Routing using Routing Information Protocol (RIP) automatically adjusts how packets travel on your network. This protocol uses a hop count metric in local and wide area networks. You can Enable or Disable dynamic routing from this page and configure the following RIP parameters: RIP Authentication: Enable or disable RIP Authentication Key: Select a key RIP Authentication Key ID: Choose RIPv1 or RIPv2. RIP Reported Interval: Choose RIPv1 or RIPv2. RIP Destination IP Address:
Routed Subnet Support	Allows you to Enable or Disable the IP addresses in your network. Click enable to enable the addresses or click disable to disable them. Enter the IP addresses that you want to enable or disable in the following fields: Select Set Number. Select a set number between 1 and 20. To change your value, click Delete This Entry and select a new value. Destination IP Address. Enter the destination IP address. This is the address of the remote network or host to which you want to assign a static route. Subnet Mask. Enter the subnet mask address. The Subnet Mask determines which portion of a Destination IP Address is the network portion and which portion is the host portion. Gateway. Enter the Gateway address. This is the IP address of the gateway device that allows for contact between the device and the remote network or host.

Configure the Routing Table

To configure the routing table, complete the following steps.

- 1 From the Setup page, click **Advanced Routing**.

- 2 From the **Select Set Number** drop-down list, select the set number (routing table entry number) that you wish to view or configure.
- 3 Complete the fields on the page.
- 4 Click **Delete This Entry** to delete (clear) the entry if desired.

Display Routing Table

To view all the static routes you have defined, complete the following steps.

- 1 From the Setup page, click **Advanced Routing**.
- 2 Click **Show Routing Table** to display the routing table.

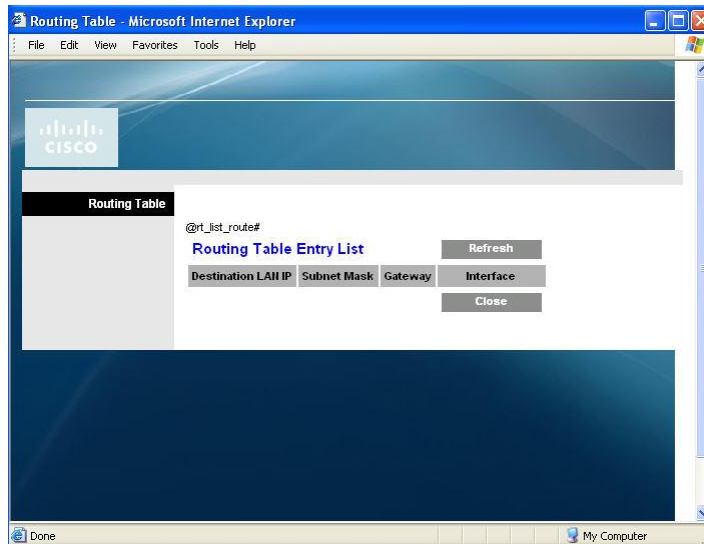

- 3 Click **Refresh** to update the list.
- 4 Click **Close** to close the window.

Security > Firewall

Advanced firewall technology deters hackers and protects the home network from unauthorized access. Use this page to configure a firewall that can filter out various types of unwanted traffic on the gateway's local network.

Select the **Firewall** tab to open the Security Firewall page.

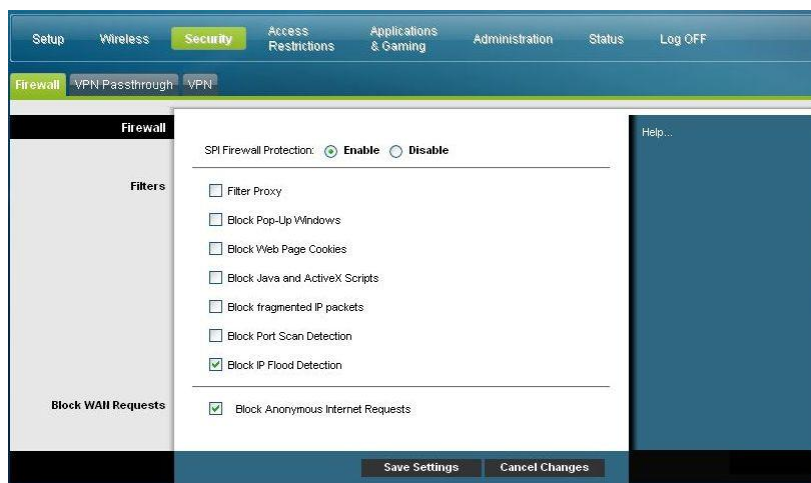

Use the descriptions and instructions in the following table to configure the firewall for your residential gateway. After you make your selections, click **Save Settings** to apply your changes or **Cancel Changes** to cancel.

Section	Field Description
Firewall	<p>SPI Firewall Protection</p> <p>SPI Firewall Protection blocks Denial of Service (DoS) attacks. A DoS attack does not attempt to steal data or damage your computers, but it overloads your Internet connection so you cannot use it.</p> <p>Select the desired option:</p> <ul style="list-style-type: none"> ■ Enable (factory default) ■ Disable
Filters	<p>Filter Proxy</p> <p>Enables/disables filter proxy. If local users have access to WAN proxy servers, they may be able to circumvent the content filters and access Internet sites blocked by the device. If you select the Filter Proxy feature, it will block access to any WAN proxy servers.</p> <p>Block Pop-Up Windows</p> <p>Enables/disables popup windows. Some commonly used applications employ popup windows as part of the application. If you disable popup windows, it may interfere with some of these applications.</p> <p>Block Web Page Cookies</p> <p>Enables/disables cookie blocking. This feature filters the unsolicited delivery of cookies to devices from the Internet to devices in your private local network. Cookies are computer files that contain personal information or web surfing behavior data.</p>

Section	Field Description
	<p data-bbox="574 264 948 289">Block Java and ActiveX Scripts</p> <p data-bbox="574 310 1360 474">Enables/disables java applets and ActiveX scripts. This feature helps to protect the devices in your private network from irritating or malicious Java applets that are sent, unsolicited, to devices in your private network from the Internet. These applets run automatically when they are received by a PC.</p> <p data-bbox="574 495 1373 588">Java is a programming language for websites. If you select the Filter Java Applets feature, you may not have access to Internet sites created using this programming language.</p> <p data-bbox="574 609 1373 772">This feature also helps to protect the devices in your private network from irritating or malicious ActiveX controls that are sent, unsolicited, to devices in your private network from the Internet. These ActiveX controls run automatically when they are received by a PC.</p>
	<p data-bbox="574 789 922 814">Block fragmented IP packets</p> <p data-bbox="574 835 1367 928">Enables/disables filtering of fragmented IP packets. This feature helps protect your private local network from Internet based denial of service attacks.</p>
	<p data-bbox="574 957 889 982">Block Port Scan Detection</p> <p data-bbox="574 1003 1338 1167">Enables/disables the gateway from responding to Internet based port scans. This feature is designed to protect your private local network from Internet based hackers who attempt to gain unsolicited access to your network by detecting open IP ports on your gateway.</p>
	<p data-bbox="574 1188 880 1213">Block IP Flood Detection</p> <p data-bbox="574 1234 1321 1327">Blocks malicious devices that are attempting to flood devices or networks with illegal broadcast packets. Also referred to as "broadcast storm."</p>
<p data-bbox="337 1356 483 1411">Block WAN Requests</p>	<p data-bbox="574 1356 1026 1381">Block Anonymous Internet Requests</p> <p data-bbox="574 1402 1360 1528">Enable this feature to keep your network from being "pinged" or detected by other Internet users. The Block Anonymous Internet Requests feature also hides your network ports. Both make it more difficult for outside users to enter your network.</p>

Security > VPN Passthrough

Use this page to configure Virtual Private Network (VPN) support. Enabling the settings on this page allows VPN tunnels using IPsec or PPTP protocols to pass through the gateway's firewall. Select the **VPN Passthrough** tab to open the Security VPN Passthrough page.

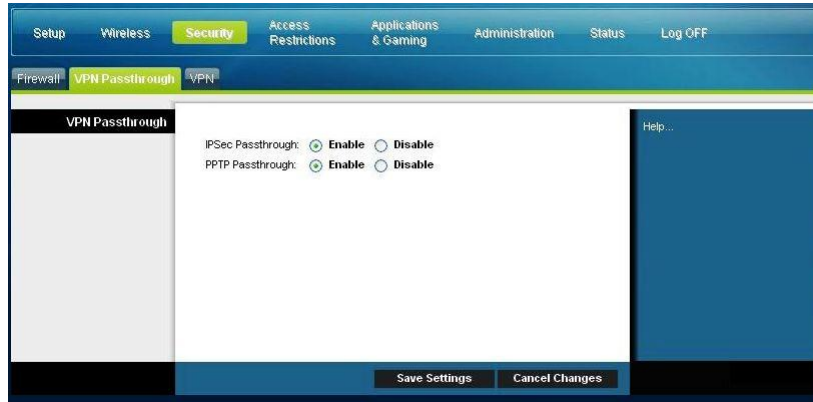

Use the descriptions and instructions in the following table to configure the VPN passthrough for your residential gateway. After you make your selections, click **Save Settings** to apply your changes or **Cancel Changes** to cancel.

Section	Field Description
VPN Passthrough	IPSec Passthrough Enables/disables Internet Protocol Security (IPsec). IPsec is a suite of protocols used to implement secure exchange of packets at the IP layer. If you enable IPSec Passthrough, applications that use IPsec (IP Security) can pass through the firewall. To disable IPSec Passthrough, select Disable . Select the desired option: <ul style="list-style-type: none">■ Enable (factory default)■ Disable
	PPTP Passthrough Enables/disables Point-to-Point Tunneling Protocol (PPTP). PPTP allows the Point-to-Point Protocol (PPP) to be tunneled through an IP network. If you enable PPTP passthrough, applications that use PPTP can pass through the firewall. To disable PPTP passthrough, select Disable . Select the desired option: <ul style="list-style-type: none">■ Enable (factory default)■ Disable

Security > VPN

A Virtual Private Network (VPN) is a connection between two endpoints in different networks that allows private data to be sent securely over public networks or other private networks. This is accomplished by creating a "VPN tunnel." A VPN tunnel connects the two PCs or networks and allows data to be transmitted over the Internet as if it were on a private network. The VPN tunnel uses IPsec to encrypt the data sent between the two endpoints and encapsulate the data within a normal Ethernet/IP frame, allowing the data to pass between networks securely and seamlessly.

A VPN provides a cost-effective and more secure alternative to using a private, dedicated, leased line for a private network. Using industry standard encryption and authentication techniques, an IPsec VPN creates a secure connection that operates as if you were directly connected to your local private network.

For example, a VPN allows users to sit at home and connect to his/her employer's corporate network and receive an IP address in their private network just as though they were sitting in their office connected to their corporate LAN.

Select the **VPN** tab to open the Security VPN page.

Use this page to configure the VPN for your residential gateway.

The screenshot displays the 'Security > VPN' configuration page. The interface includes a navigation menu at the top with options: Setup, Wireless, Security (highlighted), Access Restrictions, Applications & Gaming, Administration, Status, and Log Off. Below the menu, there are tabs for Firewall, VPN Passthrough, and VPN (selected). The main content area is titled 'VPN Tunnel' and contains the following sections:

- Select Tunnel Entry:** A dropdown menu showing '1. (Unnamed)' with 'Create', 'Delete', and 'Summary' buttons.
- IPSec VPN Tunnel:** Radio buttons for 'Enable' and 'Disable' (selected), and a 'Tunnel Name' text input field.
- Local Secure Group:** A dropdown menu for 'Subnet' and IP address fields (0 . 0 . 0 . 0) and a 'Mask' field (255 . 255 . 255 . 0).
- Remote Secure Group:** A dropdown menu for 'Subnet' and IP address fields (0 . 0 . 0 . 0) and a 'Mask' field (255 . 255 . 255 . 0).
- Remote Secure Gateway:** A dropdown menu for 'IP Addr.' and an IP address field (0 . 0 . 0 . 0).
- Key Management:**
 - 'Key Exchange Method:' dropdown set to 'Auto (IKE)'
 - 'Encryption:' dropdown set to '3DES'
 - 'Authentication:' dropdown set to 'MD5'
 - 'PFS:' dropdown set to 'Disable'
 - 'Pre-Shared Key:' text input field with masked characters
 - 'Key Lifetime:' text input field set to '3600' seconds
- Status:** A section indicating 'NOT Connected'.

At the bottom of the configuration area, there are buttons for 'Connect', 'Disconnect', 'View Log', and 'Advanced Settings'. At the very bottom of the page, there are 'Save Settings' and 'Cancel Changes' buttons.

Security VPN Tunnel Page Description

Use the descriptions and instructions in the following table to configure the VPN tunnel for your gateway. After you make your selections, click **Save Settings** to apply your changes or **Cancel Changes** to cancel.

Section	Field Description
VPN Tunnel	Select Tunnel Entry Allows you to display a list of created VPN tunnels
	Create Button Click this button to create a new tunnel entry
	Delete Button Click this button to delete all settings for the selected tunnel
	Summary Button Click this button to display the settings and status of all enabled tunnels
	IPSec VPN Tunnel Allows you to enable or disable Internet Security Protocol for the VPN tunnel
	Tunnel Name Enter the name for this tunnel
Local Secure Group	Select the local LAN user(s) that can use this VPN tunnel. This may be a single IP address or sub-network. Note that the Local Secure Group must match the remote gateway's Remote Secure Group.
	IP Enter the IP address of the local network
	Mask If the Subnet option is selected, enter the mask to determine the IP address on the local network
	Remote Secure Group Select the remote LAN user(s) behind the remote gateway who can use this VPN tunnel. This may be a single IP address, a sub-network, or any addresses. If "Any" is set, the Gateway acts as responder and accepts requests from any remote user. Note that the Remote Secure Group must match the remote gateway's Local Secure Group.
IP Enter the IP address of the remote network	
Mask If the Subnet option is selected, enter the mask to determine the IP addresses on the remote network	

Section	Field Description
Remote Secure Gateway	<p>Select the desired option, IP Addr., Any, or FQDN. If the remote gateway has a dynamic IP address, select Any or FQDN. If Any is selected, then the Gateway will accept requests from any IP address.</p> <p>FQDN</p> <p>If FQDN is selected, enter the domain name of the remote gateway, so the Gateway can locate a current IP address using DDNS</p> <p>IP</p> <p>The IP address in this field must match the public (WAN or Internet) IP address of the remote gateway at the other end of this tunnel</p>
Key Management	<p>Key Exchange Method</p> <p>The gateway supports both automatic and manual key management. When automatic key management is selected, Internet Key Exchange (IKE) protocols are used to negotiate key material for Security Association (SA). If manual key management is selected, no key negotiation is needed. Basically, manual key management is used in small static environments or for troubleshooting purposes. Note that both sides must use the same key management method.</p>

Section	Field Description
	<hr/> <p>Select one of the following options for the key exchange method:</p> <ul style="list-style-type: none"><li data-bbox="609 310 792 344">■ Auto (IKE)<ul style="list-style-type: none"><li data-bbox="657 359 1421 453">– Encryption: The Encryption method determines the length of the key used to encrypt/decrypt ESP packets. Notice that both sides must use the same method.<li data-bbox="657 468 1421 751">– Authentication: The Authentication method authenticates the Encapsulating Security Payload (ESP) packets. Select MD5 or SHA. Notice that both sides (VPN endpoints) must use the same method.<ul style="list-style-type: none"><li data-bbox="706 611 1421 674">▪ MD5: A one-way hashing algorithm that produces a 128-bit digest<li data-bbox="706 688 1421 751">▪ SHA: A one-way hashing algorithm that produces a 160-bit digest<li data-bbox="657 766 1421 894">– Perfect Forward Secrecy (PFS): If PFS is enabled, IKE Phase 2 negotiation will generate new key material for IP traffic encryption and authentication. Note that both sides must have PFS enabled.<li data-bbox="657 909 1421 1068">– Pre-Shared Key: IKE uses the Pre-Shared Key to authenticate the remote IKE peer. Both character and hexadecimal values are acceptable in this field, e.g., "My_@123" or "0x4d795f40313233". Note that both sides must use the same Pre-Shared Key.<li data-bbox="657 1083 1421 1245">– Key Lifetime: This field specifies the lifetime of the IKE generated key. If the time expires, a new key will be renegotiated automatically. The Key Lifetime may range from 300 to 100,000,000 seconds. The default lifetime is 3600 seconds. <hr/>

Section	Field Description
<ul style="list-style-type: none"> ■ Manual 	<ul style="list-style-type: none"> – Encryption: The Encryption method determines the length of the key used to encrypt/decrypt ESP packets. Note that both sides must use the same method. – Encryption Key: This field specifies a key used to encrypt and decrypt IP traffic. Both character and hexadecimal values are acceptable in this field. Note that both sides must use the same Encryption Key. – Authentication: The Authentication method authenticates the Encapsulating Security Payload (ESP) packets. Select MD5 or SHA. Note that both sides (VPN endpoints) must use the same method. <ul style="list-style-type: none"> ▪ MD5: A one-way hashing algorithm that produces a 128-bit digest ▪ SHA: A one-way hashing algorithm that produces a 160-bit digest – Authentication Key: This field specifies a key used to authenticate IP traffic. Both character and hexadecimal values are acceptable in this field. Note that both sides must use the same Authentication Key. – Inbound SPI/Outbound SPI: The Security Parameter Index (SPI) is carried in the ESP header. This enables the receiver to select the SA, under which a packet should be processed. The SPI is a 32-bit value. Both decimal and hexadecimal values are acceptable, e.g., "987654321" or "0x3ade68b1". Each tunnel must have a unique Inbound SPI and Outbound SPI. No two tunnels share the same SPI. Note that the Inbound SPI must match the remote gateway's Outbound SPI, and vice versa.
Status	This field shows the connection status for the selected tunnel. The state is either Connected or Disconnected .

Section	Field Description
Buttons	<p>Connect</p> <p>Click this button to establish a connection for the current VPN tunnel. If you have made any changes, click Save Settings to first apply your changes.</p> <p>Disconnect</p> <p>Click this button to break a connection for the current VPN tunnel.</p> <p>View Log</p> <p>Click this button to view the VPN log, which shows details of each established tunnel.</p> <p>Advanced Settings</p> <p>If the Key Exchange Method is Auto (IKE), this button provides access to additional settings relating to IKE. Click this button if the gateway is unable to establish a VPN tunnel to the remote gateway, and make sure the Advanced Settings match those on the remote gateway.</p> <ul style="list-style-type: none">■ Phase 1 - Operation Mode<p>Select the method appropriate for the remote VPN endpoint.</p><ul style="list-style-type: none">– Main: Main mode is slower but more secure– Aggressive: Aggressive mode is faster but less secure■ Local Identity<p>Select the desired option to match the Remote Identity setting at the other end of this tunnel.</p><ul style="list-style-type: none">– Local IP Address: Your WAN (Internet) IP address– Name: Your domain name■ Remote Identity<p>Select the desired option to match the Local Identity setting at the other end of this tunnel.</p><ul style="list-style-type: none">– Local IP Address: WAN (Internet) IP address of the remote VPN endpoint– Name: Domain name of the remote VPN endpoint.■ Encryption<p>This is the Encryption algorithm used for the IKE SA. It must match the setting used at the other end of the tunnel.</p>

View Log

The Security VPN View Log page shows events captured by the firewall. The log displays the following items:

- Description of the event

- Number of events that have occurred
- Last occurrence of an event
- Target and source addresses

You can view the following logs from this page:

- Access log
- Firewall log
- VPN log
- Parental Control log

The screenshot shows a log viewer interface. At the top left, there is a 'Log' header. To the right, there is a 'Type:' dropdown menu set to 'Firewall Log' and a 'Refresh' button. Below this is a table with the following data:

Description	Count	Last Occurrence	Target	Source
LAN-side SYN Flood	4	Thu Jan 01 00:00:54 1970	192.168.0.1:80	64.100.106.97:1332

At the bottom right of the interface, there is a 'Clear' button.

Click **Clear** to clear the log data.

Control Access to the Gateway

Access Restrictions > Basic Rules

Access restrictions allow you to block or allow specific kinds of Internet usage and traffic, such as Internet access, designated applications, websites, and inbound traffic during specific days and times. The Access Restrictions Basic Rules page allows you to configure parental controls on the residential gateway, and to monitor the individuals who are authorized to set parental controls.

Select the **Basic Rules** tab to open the Access Restrictions Basic Rules page.

Use the descriptions and instructions in the following table to configure the access restrictions basic rules for your residential gateway. After you make your selections, click **Save Settings** to apply your changes or **Cancel Changes** to cancel.

Section	Field Description
Parental Control Basic Setup	<p data-bbox="634 264 971 289">Parental Control Activation</p> <p data-bbox="634 310 1377 436">Allows you to enable or disable parental controls. To enable parental controls, select the Enable Parental Control check box and click Apply. To disable parental controls, clear the Enable Parental Control check box and click Apply.</p> <p data-bbox="634 457 753 483">Add Rule</p> <p data-bbox="634 504 1263 529">Adds and saves a new Rule to the list of content rules</p> <p data-bbox="634 550 797 575">Remove Rule</p> <p data-bbox="634 596 1235 621">Removes the selected rule from the content rule list</p>
Keyword List	<p data-bbox="634 653 802 678">Keyword List</p> <p data-bbox="634 699 1377 804">Allows you to create a list of keywords. Any attempt to access a URL that contains any of the keywords in this list will be blocked by the gateway</p> <p data-bbox="634 825 915 850">Add/Remove Keyword</p> <p data-bbox="634 871 1289 926">Allows you to add new keywords to the list or to delete selected keywords from the list</p>
Blocked Domain List	<p data-bbox="634 947 894 972">Blocked Domain List</p> <p data-bbox="634 993 1377 1098">Allows you to create a list of domains that the gateway should block access to. Any attempt to access any of the Domains in this list will be blocked by the gateway</p> <p data-bbox="634 1119 899 1144">Add/Remove Domain</p> <p data-bbox="634 1165 1377 1220">Allows you to add new domains to the list or to delete selected domains from the list</p>
Allowed Domain List	<p data-bbox="634 1241 899 1266">Allowed Domain List</p> <p data-bbox="634 1287 1338 1350">Allows you to create a list of domains to which the gateway allows access</p> <p data-bbox="634 1371 1013 1396">Add/Remove Allowed Domain</p> <p data-bbox="634 1417 1377 1488">Allows you to add new domains to the list or to delete selected domains from the list</p>

Section	Field Description
Override the Password	<p>Password</p> <p>Allows you to create a password to temporarily override user access restrictions to a blocked Internet site</p> <p>Re-Enter Password</p> <p>Re-enter the same password for confirmation of the override password in the previous field</p> <p>Access Duration</p> <p>Allows you to designate an amount of time in minutes that the Override password will allow temporary access to a restricted Internet site</p> <p>Apply</p> <p>Saves all additions, edits, and changes</p>

To use keyword and domain blocking

Keyword and Domain blocking allows you to restrict access to Internet sites by blocking access to those sites based on a word or a text string contained in the URLs used to access those Internet sites.

Domain blocking allows you to restrict access to Websites based on the site's Domain Name. The Domain Name is the portion of the URL that precedes the familiar .COM, .ORG, or .GOV extension.

Keyword blocking allows you to block access to Internet sites based on a Keyword or text string being present anywhere in the URL, not just in the Domain Name.

Note: The Domain blocking feature blocks access to any Domain in the Domain List. It will also block Domains, any portion of which contains an exact match to entries in the list.

For example, if you enter **example.com** as a Domain, any site that contains "example.com" will be blocked. Generally, you do not want to include "www." in a Domain Name since doing so limits the blocking to only the site that matches that Domain Name exactly. For instance, if you enter **www.example.com** into the list, only the one site that matches that name exactly will be blocked. Consequently, if you do not include the "www.," then all sites within and associated with "example.com" will be blocked.

Block Services

You can filter access to various applications accessed over the Internet, such as FTP or telnet, by selecting up to two services to block in the Blocked Services section.

The Blocked Services drop-down menu offers a choice of preset applications. If you select a preset application, its port numbers and protocol are displayed and cannot be changed.

If the application you want to block is not listed, select User-Defined. Then, enter the port range and protocol for the service you wish to block.

To remove a block, select **None** from the Blocked Services drop-down menu.

Click the **Save Settings** button to save the policy settings.

Block Access to Websites

If you wish to block access to websites, use the **Blocked Domain List** or the **Keyword List**

To use the **Blocked Domain List**, enter the URLs or domain names of the websites you wish to block.

Use the **Keyword List** to enter the keywords you wish to block. If any of these keywords appears in the URL of a website, access to the site will be blocked. Note that only the URL is check, not the content of each webpage.

Access Restrictions > Time of Day Rules

Use the Access Restrictions Time of Day Rules page to configure web access filters to block all Internet traffic to and from specific network devices based on day of week and time of day settings that you select.

Select the **Time of Day Rules** tab to open the Access Restrictions Time of Day Rules Page. The following illustration is an example of the Access Restrictions Time of Day Rules page.

Note: The residential gateway uses the network time of day clock that is managed by your data service provider. The time of day clock must be accurate and represent the time of day in your time zone for this feature to operate properly. Verify that the Status and Set Time pages reflect the correct time of day. If they do not reflect the correct time of day, contact your data service provider. You can also adjust your settings to account for the difference.

The screenshot displays the 'Time of Day Rules' configuration interface. At the top, a navigation bar includes 'Setup', 'Wireless', 'Security', 'Access Restrictions' (highlighted), 'Applications & Gaming', 'Administration', 'Status', and 'Log OFF'. Below this, a sub-menu shows 'IP Address Filtering', 'MAC Address Filtering', 'Basic Rules', 'Time of Day Rules' (highlighted), 'User Setup', and 'Local Log'. The main content area is divided into two sections: 'Tod Filter' and 'Schedule'. The 'Tod Filter' section contains an input field, an 'Add' button, and a status indicator 'No filters entered.' with an 'Enabled' checkbox and a 'Remove' button. The 'Schedule' section is further divided into 'Days to Block' and 'Time to Block'. Under 'Days to Block', there are checkboxes for 'Everyday', 'Sunday', 'Monday', 'Tuesday', 'Wednesday', 'Thursday', 'Friday', and 'Saturday'. Under 'Time to Block', there is an 'All day' checkbox and two time pickers for 'Start' and 'End', each with fields for hour, minute, and AM/PM. At the bottom of the page, there are 'Save Settings' and 'Cancel Changes' buttons.

Access Restrictions Time of Day Rules Page Description

Use the descriptions and instructions in the following table to configure the time of day rules for your residential gateway. After you make your selections, click **Save Settings** to apply your changes or **Cancel Changes** to cancel.

Section	Field Description
Tod Filter	<p>Add</p> <p>Allows you to add a new Time of Day access filter or rule. Enter the name of the filter and click the Add key to add the filter to the list. Time of Day rules are used to restrict Internet access based on the day and time.</p>
	<p>Remove</p> <p>Removes the selected filter from the Time of Day filter list.</p>
Schedule	<p>Days to Block</p> <p>Allows you to control access based on days of the week</p>
	<p>Time to Block</p> <p>Allows you to control access based on time of day</p>

Access Restrictions > User Setup

Use the Access Restrictions User Setup page to set up additional accounts and user profiles for household members. Each profile can be assigned customized levels of Internet access as defined by the access rules assigned to that user's profile.

Important: These additional accounts do not grant administrative access to the gateway.

Note: Once you define and enable user profiles, each user must sign-on each time they wish to access the Internet. The user can sign-on when the pop-up sign-on screen appears in their Web browser. The user must enter their correct user name and password in order to gain Internet access.

Select the **User Setup** tab to open the Access Restrictions User Setup page.

Access Restrictions User Setup Page Description

Use the descriptions and instructions in the following table to configure the user setup for your residential gateway. After you make your selections, click **Save Settings** to apply your changes or **Cancel Changes** to cancel.

Section	Field Description
User Configure	<p>Add User</p> <p>Allows you to add a new user profile. Enter the name of the user and click the Add User button to add the user to the list.</p>
	<p>User Settings</p> <p>Allows you to edit a user profile by using the drop-down menu to edit a user profile. The drop-down menu allows you to recall the profile to be edited. User names and passwords are case-sensitive.</p> <p>Make sure to check the Enable box to activate the user profile. If a profile is not active, that user will not have any access to the Internet.</p> <p>To remove a user profile, use the drop-down menu to select the user to be removed and click the Remove User button.</p>
	<p>Password</p> <p>Enter the selected user's password in this field. Each user must enter their User Name and Password each time they use the Internet. User names and passwords are case-sensitive.</p> <p>Note: The residential gateway will allow each user access to the Internet, subject to the rules selected on this page for that user.</p>
	<p>Re-Enter Password</p> <p>Re-enter the same password for confirmation of the password in the previous field.</p>

Section	Field Description
	<hr/> Trusted User <p>Check this box if the currently selected user is to be designated a trusted user. Trusted users are not subject to Internet access rules.</p> <hr/>
	Content Rule <p>Select the Content Rule for the current user profile. Content Rules must first be defined by going to the Rules Configuration page. You can access the Rule Configuration page by clicking on the “Basic Rules” tab on this page.</p> <hr/>
	Time Access Rule <p>Select the Time Access Rule for the current user profile. Time Access Rules must first be defined by going to the Time of Day Rules page. You can access the Time of Day Rules page by clicking on the “Time of Day Rules” tab on this page.</p> <hr/>
	Session Duration <p>1440 minutes [Factory default when a user is created. Otherwise, it is 0 (zero)].</p> <p>Enter the amount of time in minutes that the user will be granted Internet access beginning at the time they sign on using their User Name and Password.</p> <p>Note: Set the Session Duration to 0 (zero) to prevent session timeout.</p> <hr/>
	Inactivity Time <p>60 minutes [Factory default when a user is created. Otherwise, it is 0 (zero)].</p> <p>Enter the amount of time during a user session where there is no Internet access activity, indicating that the user is no longer online. If the inactivity timer is triggered, the user session will be closed automatically. In order to regain Internet access, the user must log in again with their User Name and Password.</p> <p>Note: Set the Inactivity time value to 0 (zero) to prevent timeout due to inactivity.</p> <hr/>

Access Restrictions > IP Address Filtering

Use the Access Restrictions IP Filtering page to configure IP address filters. These filters block a range of IP addresses from accessing the Internet.

Note: If you are not familiar with the advanced settings detailed in this section, contact your service provider before you attempt to change any of the residential gateway default advanced IP filtering settings.

Select the **IP Address Filtering** tab to open the Access Restrictions IP Filtering page. After you make your selections, click **Save Settings** to apply your changes or **Cancel Changes** to cancel.

The screenshot shows the 'IP Address Filtering' configuration page. The top navigation bar includes 'Setup', 'Wireless', 'Security', 'Access Restrictions' (highlighted), 'Applications & Gaming', 'Administration', 'Status', and 'Log OFF'. Below this, a sub-navigation bar shows 'IP Address Filtering' (highlighted), 'MAC Address Filtering', 'Basic Rules', 'Time of Day Rules', 'User Setup', and 'Local Log'. The main content area is titled 'IP Filtering' and contains a table with three columns: 'Start Address', 'End Address', and 'Enable'. Each row in the table has input fields for the start and end addresses and a checkbox for the 'Enable' column. At the bottom of the page, there are two buttons: 'Save Settings' and 'Cancel Changes'.

Start Address	End Address	Enable
0.0.0.0	0.0.0.0	<input type="checkbox"/>
0.0.0.0	0.0.0.0	<input type="checkbox"/>
0.0.0.0	0.0.0.0	<input type="checkbox"/>
0.0.0.0	0.0.0.0	<input type="checkbox"/>
0.0.0.0	0.0.0.0	<input type="checkbox"/>
0.0.0.0	0.0.0.0	<input type="checkbox"/>
0.0.0.0	0.0.0.0	<input type="checkbox"/>
0.0.0.0	0.0.0.0	<input type="checkbox"/>
0.0.0.0	0.0.0.0	<input type="checkbox"/>
0.0.0.0	0.0.0.0	<input type="checkbox"/>
0.0.0.0	0.0.0.0	<input type="checkbox"/>
0.0.0.0	0.0.0.0	<input type="checkbox"/>

Access Restrictions > MAC Address Filtering

Use the Access Restrictions MAC Address Filtering page to configure MAC address filters. These filters permit you to allow or block a range of MAC addresses from accessing the Internet based on MAC Address.

Note: If you are not familiar with the advanced settings detailed in this section, contact your service provider before you attempt to change any of the residential gateway default advanced IP filtering settings.

Select the **MAC Address Filtering** tab to open the Access Restrictions MAC Address Filtering page.

The screenshot shows the 'MAC Address Filtering' configuration page. The top navigation bar is the same as in the previous screenshot. The sub-navigation bar shows 'MAC Address Filtering' (highlighted), 'IP Address Filtering', 'Basic Rules', 'Time of Day Rules', 'User Setup', and 'Local Log'. The main content area is titled 'MAC Filtering' and contains a 'Block Listed' dropdown menu with an 'Apply' button. Below this, there is a text input field for 'MAC Addresses (example: 01:23:45:67:89:AB)' and an 'Add MAC Address' button. A list box below the input field shows 'Addresses entered: 0/20'. At the bottom of the list box area, there are 'Remove MAC Address' and 'Clear All' buttons. At the bottom of the page, there is a 'Cancel Changes' button.

The Block/Pass drop down menu allows you to block or pass Internet access to the MAC addresses of the devices you list in the MAC Address Filters table. The following table describes the function of the Block/Pass drop-down menu. After you make your selections, click **Save Settings** to apply your changes or **Cancel Changes** to cancel.

Field Name	Description
MAC Filtering	Block Listed (Default) Select Block to deny Internet access to the MAC addresses of the devices you list in the table. All other MAC addresses will be allowed Internet access.
	Pass Listed Select Pass Listed to allow Internet access only to the MAC addresses of the devices you list in the table. Any MAC addresses <i>not</i> listed in the table will be denied Internet access.

Function Keys

The following function keys appear on the Advanced Settings - MAC Address Filtering page.

Key	Description
Apply	Saves the values you enter into the fields without closing the page
Add MAC Address	Saves the MAC Address entered in the associated text field
Remove MAC Address	Removes the selected MAC address
Clear All	Removes all defined MAC addresses

Access Restrictions > Local Log

This page allows you to track, by user, any attempts made by that user to access Internet sites that are restricted. From this page, you can also view events captured by the parental control event-reporting feature.

Select the **Local Log** tab to open the Access Restrictions Local Log page.

The following illustration is an example of the Access Restrictions Local Log page.



Section	Field Description
Local Log	Last Occurrence
Parental Control - Event Log	Displays the time of the most recent attempt to access a restricted Internet site
	Action
	Displays the action taken by the system
	Target
	Displays the URL of the restricted site
	User
	Displays the user who attempted a restricted site
	Source
	Displays the IP address of the PC that was used when attempting to access a restricted website

Manage the Gateway

Administration > Management

The Administration Management page allows the network's administrator to manage specific gateway functions for access and security. Select the **Management** tab to open the Administration Management page.

Important: The following page displays when **DHCP** (factory default) is the Connection Mode. The page that displays when **Static IP** is selected is shown and described later in this section.

The screenshot shows the Administration Management page with the following settings:

- Gateway Setup (WAN)**
 - Internet Connection Type: **Connection Mode:** DHCP (dropdown), **MTU size:** 0
- Gateway Access**
 - Local Access**
 - Current User Name: user
 - Change Current User Name to: [text input]
 - Change Password to: [text input]
 - Re-Enter New Password: [text input]
 - Remote Access**
 - Remote Management: Enable Disable
 - Management Port: 8080
- UPnP**
 - UPnP: Enable Disable
- IGMP**
 - IGMP Proxy: Enable Disable

Buttons at the bottom: Save Settings, Cancel Changes

Administration Management Page Description

Use the descriptions and instructions in the following table to configure the administration management for the residential gateway when DHCP or Static IP connection mode is selected. After you make your selections, click **Save Settings** to apply your changes or **Cancel Changes** to cancel.

Field	Description
Gateway Setup (WAN)	Connection Mode: This setting allows you to determine how the WAN (or gateway interface to the Internet) obtains its IP address.

Field	Description
Internet Connection Type	DHCP (factory default) Allows the gateway to obtain a public IP address automatically

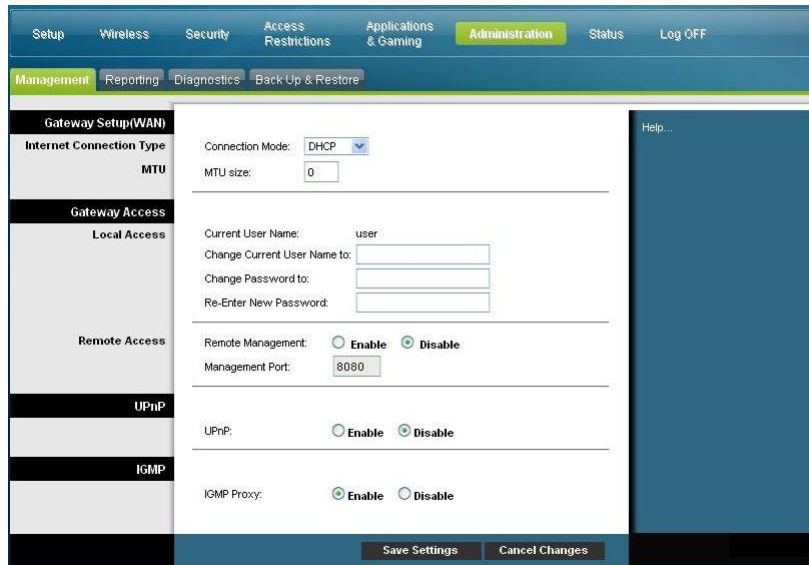

Static IP

Allows you to specify the WAN IP address and corresponding server information as static or fixed values that will be used whenever the gateway goes online

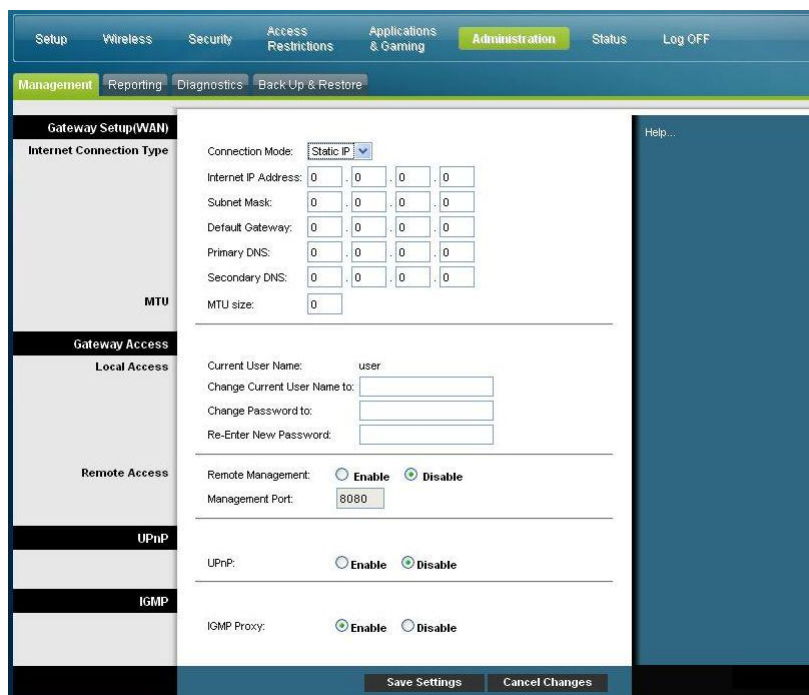

Internet IP Address

Enter the gateway's IP address (as seen from the Internet)

Field	Description
	<p>Subnet Mask</p> <p>Enter the gateway's subnet mask (as seen from the Internet, including your service provider)</p> <p>Default Gateway</p> <p>Enter the default gateway of the service provider's server</p> <p>Primary DNS</p> <p>Enter the primary domain name server IP address(es) provided by your service provider. This is required.</p> <p>Secondary DNS</p> <p>Enter the secondary domain name server IP address(es) provided by your service provider. This is optional.</p>
MTU	<p>MTU size</p> <p>MTU is the Maximum Transmission Unit. The MTU size specifies the largest packet size permitted for Internet transmission. Select Manual if you want to manually enter the largest packet size that will be transmitted. 1500 is the recommended size. You should leave this value in the 1200 to 1500 range. To have the device select the best MTU for your Internet connection. The factory default = 0 (automatic)</p>
Gateway Access	<p>Current User Name:</p>
Local Access	<p>Identifies the currently logged in user</p> <p>Change Current User Name to:</p> <p>This field allows you to change your user name. If you want to change your user name, enter your new user name in this field and click Save Settings to apply the change.</p> <p>Note: The factory default user name is a blank field.</p> <p>Change Password to:</p> <p>This field allows you to change your password. If you want to change your password, enter your new password in this field. Then, re-enter your new password in the Re-Enter New Password field and click Save Settings to apply the change.</p> <p>Note: The factory default password is a blank field.</p> <p>Re-Enter New Password:</p> <p>Allows you to re-enter the new password. You must enter the same password as the one entered in the previous field Change Password to. After you re-enter your new password, click Save Settings to apply the change.</p>

Field	Description
Remote Access	<p data-bbox="586 264 846 289">Remote Management</p> <p data-bbox="586 310 1365 573">Allows you to enable or disable remote management. This feature allows you to access and manage your gateway settings from the Internet when you are away from home. To allow remote access, select Enable. Otherwise, keep the default setting as Disable. The protocol HTTP is required for remote management. To remotely access the device, enter https://xxx.xxx.xxx.xxx:8080 (the x's represent the device's Internet IP address, and 8080 represents the specified port) in your web browser's Address field.</p> <p data-bbox="586 594 805 619">Management Port</p> <p data-bbox="586 640 1365 730">Enter the port number that will be open to outside access. The default setting is 8080. This port must be used when you establish a remote connection.</p>
UPnP	<p data-bbox="586 751 659 777">UPnP</p> <p data-bbox="586 798 1365 930">Universal Plug and Play (UPnP) allows Windows XP and Vista to automatically configure the Gateway for various Internet applications, such as gaming and videoconferencing. If you want to use UPnP, keep the default, Enable. Otherwise, select Disable.</p>
IGMP	<p data-bbox="586 951 740 976">IGMP Proxy</p> <p data-bbox="586 997 1365 1224">Internet Group Multicast Protocol (IGMP) is used to establish membership in a multicast group and is commonly used for multicast streaming applications. For example, you may have Internet Protocol Television (IPTV) with multiple set-top boxes on the same local network. These set-top boxes have different video streams running simultaneously, so you should use the IGMP feature of the Router.</p> <p data-bbox="586 1245 1365 1339">IGMP forwarding (proxying) is a system that improves multicasting for LAN-side clients. If the clients support this option, keep the default, Enable. Otherwise, select Disable.</p>

Administration > Reporting

Administration reporting allows you to email various system activities to your email address.

Select the **Reporting** tab to open the Administration Reporting page.

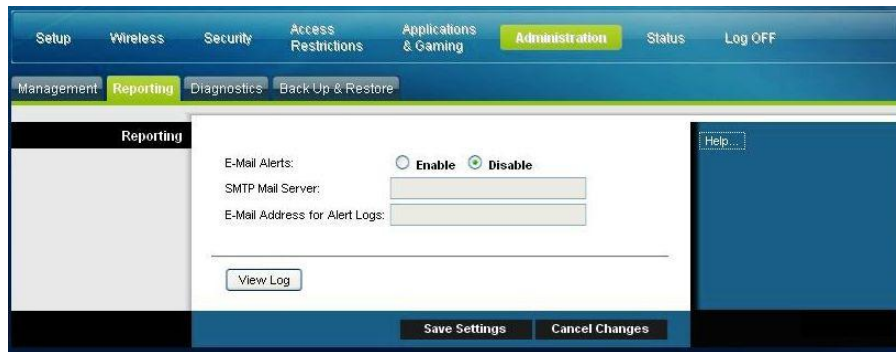

Use the descriptions and instructions in the following table to configure the reporting feature on the gateway. After you make your selections, click **Save Settings** to apply your changes or **Cancel Changes** to cancel.

Section	Field Description
Reporting	<p>E-Mail Alerts</p> <p>If enabled, an e-mail will be sent immediately if any reportable events are detected. To use this feature, provide the necessary e-mail address information.</p>
	<p>SMTP Mail Server</p> <p>Enter the address (domain name) or IP address of the Simple Mail Transport Protocol (SMTP) server you use for outgoing e-mail.</p>
	<p>E-Mail Address for Alert Logs</p> <p>Enter the e-mail address that should receive the logs.</p>

View Log

To view the logs, complete the following steps.

- 1 Click **View Log**. A new window opens with the log data page.

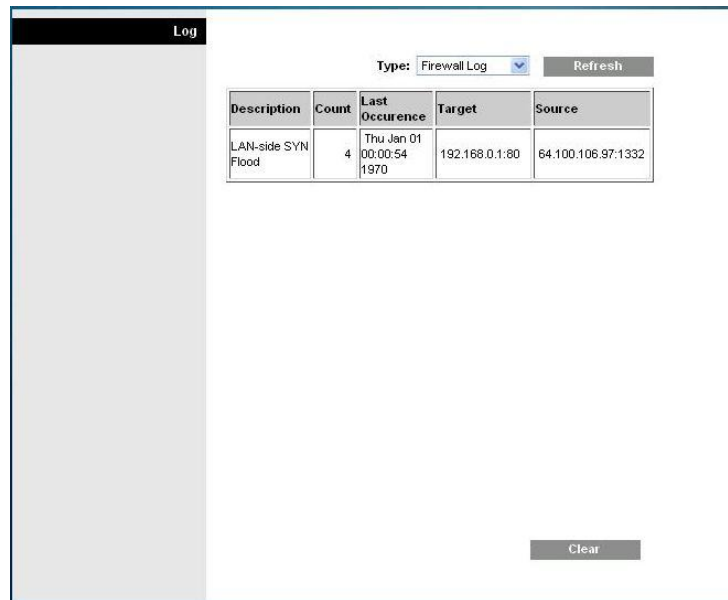

- 2 To view a particular log, select one of the following options from the Type drop-down menu:
 - All
 - Access Log
 - Firewall Log
 - VPN Log
- 3 After the log data is displayed, use one of the following options:
 - Click the **Page Refresh** button to update the log.
 - Click the **Clear** button to clear all the information in the current log.
 - Click the **Previous Page** button to go back to the information previously displayed.
 - Click the **Next Page** button to see the next section of the log, if available.

Administration > Diagnostics

Administration diagnostics allow you to check the status of your Internet connection by using a Ping test.

Select the **Diagnostics** tab to open the Administration Diagnostics page.



Use the descriptions and instructions in the following table to configure the diagnostics feature on the gateway. After you make your selections, click **Save Settings** to apply your changes or **Cancel Changes** to cancel.

Section	Field Description
Ping Test	Ping Target IP
Ping Test Parameters	The IP address that you want to ping.
	Ping Size
	The size of the packet you want to use.
	Number of Pings
	The number of times you wish to ping the target device.
	Ping Interval
	The time period (milliseconds) between each ping.
	Ping Timeout
	The desired time period (milliseconds) of the timeout. If no response is received within this ping period, the ping test is considered a failure.
	Start Test
	To start a test, complete the following steps.
	Click Start Test to begin the test. A new page opens and displays a summary of the test results.
	Click the Save Settings to save the test results or click Cancel Changes to cancel the test.

Administration > Backup & Restore

Administration Backup & Restore allows you to back up your configuration of the Gateway and store it on your computer. You can use this file to restore a previously saved configuration for your Gateway.

Select the **Back Up & Restore** tab to open the Administration Back Up & Restore page.



CAUTION:

Restoring a configuration file will destroy (overwrite) all of the existing settings.



Section	Field Description
Back Up Configuration	Use the Back Up Configuration feature to save a copy of the current configuration and store the file on your computer. Click Back Up to start the download.
Restore Configuration	Use the Restore Configuration feature to restore a previously saved configuration file. Click Browse to select the configuration file, and then click Restore to load the configuration file to the device.

Administration > Factory Defaults

The Administration Factory Defaults page allows you to restore the configuration to its factory default settings. Select the **Factory Defaults** tab to open the Administration Factory Defaults page.



CAUTION:

If you restore the factory defaults, the gateway will lose all of the settings you have entered. Before you reset the gateway to its factory default settings, write down all of your custom settings. After the defaults have been restored, you will have to re-enter all of your configuration settings.

Manage the Gateway



Restore Factory Defaults

To restore factory defaults, click **Restore Factory Defaults** to reset all configuration settings to their default values. Any settings you have saved will be lost when the default settings are restored.

Monitor Gateway Status

This section describes the options available under the Status tab that you can use to monitor the status of the residential gateway and to perform diagnostics on the device and the network.

Status > Gateway

The Gateway Status page displays information about the gateway and its current settings. The on-screen information varies depending on the Internet Connection type you use.

Select the **Gateway** tab to open the Status Gateway screen. Click **Refresh** to update the data displayed on-screen.



Use the descriptions in the following table to review the status of your gateway and your Internet connection.

Section	Field Description
Gateway Information	Firmware Version
	The version number of the firmware.
	MAC Address (CM MAC Address)
	A unique alphanumeric address for the cable modem coaxial interface, which is used to connect to the cable modem termination system (CMTS) at the headend. A media access control (MAC) address is a hardware address that uniquely identifies each node of a network.
	Current Time
	The time, based on the time zone selected on the Basic Setup page is displayed.

Section	Field Description
Internet Connection	IP Address
	Displays the IP address of the WAN interface. This address is assigned to the gateway when it goes online.
	Subnet Mask
	Displays the subnet mask for your WAN port. This address is automatically assigned to your WAN port by your ISP except when a static IP address is set up.
	Default Gateway
	The IP address of the ISP's Default Gateway.
DNS1-3	The DNS IP addresses currently used by the gateway.
	WINS
	The WINS IP address currently used by the gateway.

Status > Local Network

The Local Network Status page displays information about the status of the local area network.

Select the **Local Network** tab to open the Status Local Network page. Click **Refresh** to update the data on the page.



Use the following table to review the status of your gateway and your Internet connection.

Section	Field Description
Local Network	MAC Address
	A unique alphanumeric address for the private LAN home network. A MAC address is a hardware address that uniquely identifies each node of a network.
	IP Address
	Displays the IP address for the LAN subnet
	Subnet Mask
	Displays the subnet mask for your LAN
	DHCP Server
Displays the status of your local DHCP server (Enabled or Disabled)	
Starting IP Address	Displays the beginning of the range of IP addresses used by the DHCP server in your gateway
	End IP Address
	Displays the end of the range of IP addresses used by the DHCP server

DHCP Client Table Click **DHCP Client Table** to show which devices are attached to your LAN that have been issued IP addresses by the DHCP server in the gateway. On the DHCP Client Table page, you will see a list of DHCP clients (computers and other network devices) with the following information: Client Host Names, IP Addresses, MAC Addresses, and the length of time before their assigned IP addresses expire. To retrieve the most up-to-date information, click **Refresh**. To exit this page and return to the Local Network page, click **Close**.

The following illustration shows an example of the DHCP Client Table.

DHCP Client Table				
DHCP Client Table				
DHCP Server IP Address: 192.168.0.1				
MAC Address	IP Address	Subnet Mask	Duration	Expires
0015587e4b41	192.168.0.10	255.255.255.0	D:00 H:01 M:00 S:00	Fri Sep 25 00:15:59 2009
001f3ccdc7fe	192.168.0.11	255.255.255.0	D:00 H:01 M:00 S:00	Fri Sep 25 00:16:16 2009

Section	Field Description
ARP/RARP Table	Click ARP/RARP Table to see a complete list of all devices that are connected to your network. To retrieve the most up-to-date information, click Refresh . To exit this page and return to the Local Network page, click Close .

The following illustration shows an example of the ARP/RARP Table.

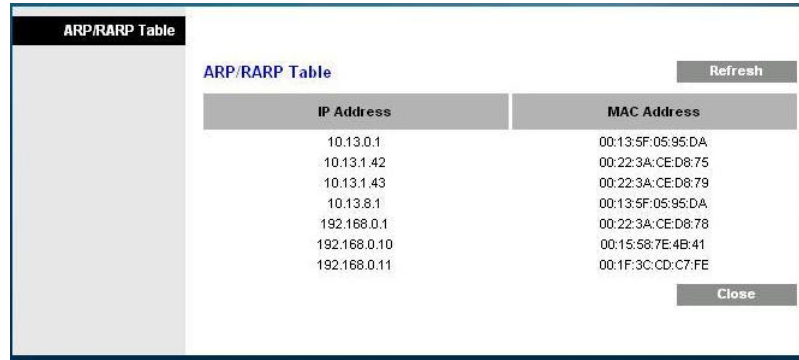

Status > Wireless

The Wireless Network Status page displays basic information about the wireless network of the gateway.

Select the **Wireless** tab to open the Status Wireless page. Click **Refresh** to update the data on the page.



Status Wireless Page Description

Use the following table to review the status of your wireless network.

Section	Field Description
Wireless Network	MAC Address
	Displays the MAC Address of your gateway's local wireless access point.
	Radio Band
	Displays one of the following radio band frequencies currently in operation:
	<ul style="list-style-type: none"> ■ 2.4 GHz ■ 5 GHz ■ 2.4 and 5 GHz
	Note: Not all products support the 5 GHz radio band.
	Network Name (SSID)
	Displays the name or service set identifier (SSID) of your wireless access point.
	Channel Width
	Displays the channel bandwidth setting selected on the Basic Wireless Settings page.
Wide Channel	
Displays the Wide Channel setting selected on the Basic Wireless Settings page.	
Standard Channel	
Displays the Standard Channel setting selected on the Basic Wireless Settings page.	
Security	
Displays the security method used by your wireless network.	
SSID Broadcast	
Displays the status of the gateway's SSID Broadcast feature.	

Status > DOCSIS WAN

DOCSIS WAN Status displays information about the system of your cable modem.

Monitor Gateway Status

Select the **DOCSIS WAN** tab to open the Status DOCSIS WAN page.

The screenshot shows a web interface with a navigation bar at the top containing 'Setup', 'Wireless', 'Security', 'Access Restrictions', 'Applications & Gaming', 'Administration', 'Status', and 'Log OFF'. Below the navigation bar, there are tabs for 'Gateway', 'Local Network', 'Wireless', and 'DOCSIS WAN'. The 'DOCSIS WAN' tab is selected. The main content area is divided into three sections: 'About', 'Downstream Channels', and 'Upstream Channels'. The 'About' section lists gateway details: Model (Cisco EPC3925), Vendor (Cisco), Hardware Revision (1.0), Serial Number (222596078), MAC Address (00:22:3acc:d8:75), Bootloader Revision (2.3.0_R1), Current Software Revision (epc3925-ESIP-16-v302r22905c-090911), Firmware Name (epc3925-ESIP-16-v302r22905c-090911.bin), Firmware Build Time (Sep 11 2009 17:33:41), and Cable Modem Status (Operational). The 'Downstream Channels' section is a table with columns for Channel, Power Level, and Signal to Noise Ratio. The 'Upstream Channels' section is a table with columns for Channel and Power Level. A 'Refresh' button is located at the bottom right of the page.

Channel	Power Level	Signal to Noise Ratio
Channel 1:	12.6 dBmV	49.9 dBmV
Channel 2:	12.3 dBmV	49.0 dBmV
Channel 3:	11.9 dBmV	48.9 dBmV
Channel 4:	11.2 dBmV	48.5 dBmV
Channel 5:	0.0 dBmV	0.0 dBmV
Channel 6:	0.0 dBmV	0.0 dBmV
Channel 7:	0.0 dBmV	0.0 dBmV
Channel 8:	0.0 dBmV	0.0 dBmV

Channel	Power Level
Channel 1:	31.7 dBmV
Channel 2:	0.0 dBmV
Channel 3:	0.0 dBmV
Channel 4:	0.0 dBmV

DOCSIS WAN Page Description

Use the descriptions in the following table to review the status of your DOCSIS WAN network.

Section	Field Description
About	Model
	Displays the name of the residential gateway.
	Vendor
	Displays the manufacturer of the residential gateway.
	Hardware Revision
	Displays the revision of the circuit board design.
	Serial Number
	Displays the unique serial number of the residential gateway.
MAC Address (CM MAC Address)	Displays the CM MAC Address. The CM MAC Address is a unique alphanumeric address for the cable modem coaxial interface, which is used to connect to the CMTS at the headend. A MAC address is a hardware address that uniquely identifies each node of a network.
	Bootloader Revision
Displays the boot revision code version.	

Section	Field Description
	Current Software Revision Displays the revision version of the firmware.
	Firmware Name Displays the name of the firmware.
	Firmware Build Time Displays the date and time the firmware was built.
	Cable Modem Status Displays one of the possible current states of the gateway.
Downstream Channels	Channels 1-8 Displays the power level and the signal to noise ratio of the active downstream channels.
Upstream Channels	Channels 1-4 Displays the power level of the active upstream channels.

Status > DOCSIS Signal

Important: This page is only visible until the gateway goes online. After the gateway is online and registered on the network, this page is no longer visible.

Important: Once the gateway is online, the remaining status can only be accessed by an authorized service technician.

The DOCSIS Signal Status page displays a detailed status report of the DOCSIS signal for each of the downstream and upstream channels.

The downstream channels section reports the status of the following items:

- Channel ID
- Downstream Frequency
- Modulation
- Power Level
- Signal-to-Noise Ratio

The upstream channels section reports the status of the following items:

- Channel ID
- Upstream Frequency
- Modulation
- Bit Rate

Monitor Gateway Status

■ Power Level

Select the **DOCSIS Signal** tab to open the Status DOCSIS Signal page.

Downstream Channels Section Example

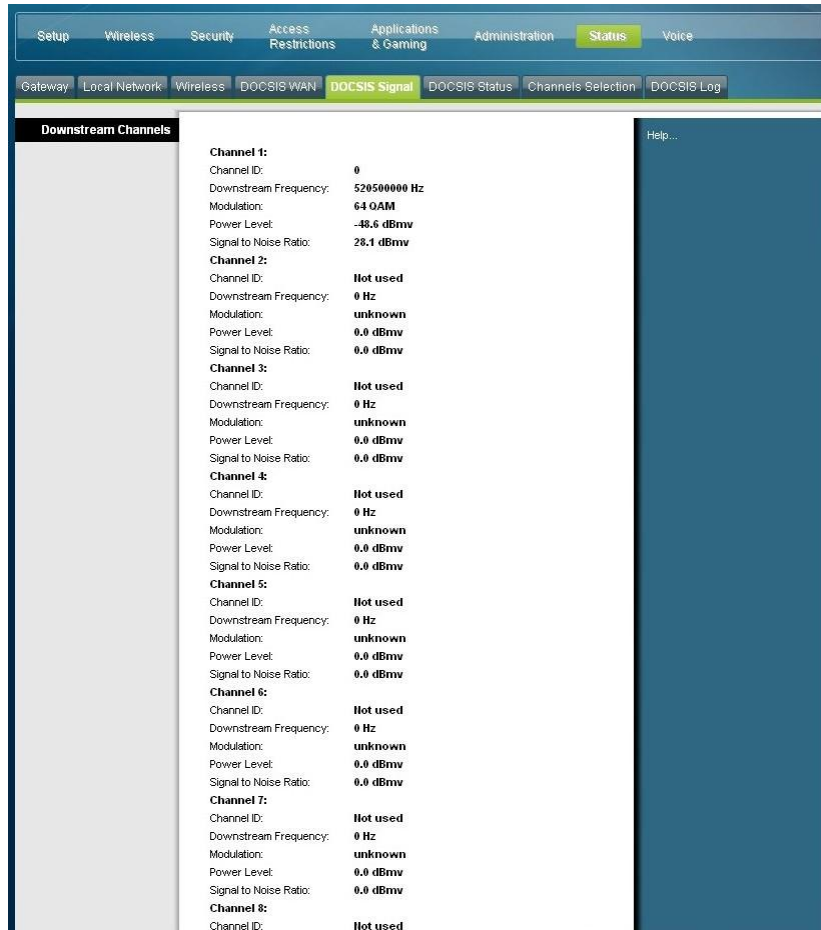

The screenshot displays the 'DOCSIS Signal' status page. The navigation menu at the top includes Setup, Wireless, Security, Access Restrictions, Applications & Gaming, Administration, Status (highlighted), and Voice. Below this, a secondary menu shows Gateway, Local Network, Wireless, DOCSIS WAN, DOCSIS Signal (highlighted), DOCSIS Status, Channels Selection, and DOCSIS Log. The main content area is titled 'Downstream Channels' and lists the following data:

Channel ID	Downstream Frequency	Modulation	Power Level	Signal to Noise Ratio
Channel 1:				
Channel ID:	0			
Downstream Frequency:	520500000 Hz			
Modulation:	64 QAM			
Power Level:	-48.6 dBmV			
Signal to Noise Ratio:	28.1 dBmV			
Channel 2:				
Channel ID:	Hot used			
Downstream Frequency:	0 Hz			
Modulation:	unknown			
Power Level:	0.0 dBmV			
Signal to Noise Ratio:	0.0 dBmV			
Channel 3:				
Channel ID:	Hot used			
Downstream Frequency:	0 Hz			
Modulation:	unknown			
Power Level:	0.0 dBmV			
Signal to Noise Ratio:	0.0 dBmV			
Channel 4:				
Channel ID:	Hot used			
Downstream Frequency:	0 Hz			
Modulation:	unknown			
Power Level:	0.0 dBmV			
Signal to Noise Ratio:	0.0 dBmV			
Channel 5:				
Channel ID:	Hot used			
Downstream Frequency:	0 Hz			
Modulation:	unknown			
Power Level:	0.0 dBmV			
Signal to Noise Ratio:	0.0 dBmV			
Channel 6:				
Channel ID:	Hot used			
Downstream Frequency:	0 Hz			
Modulation:	unknown			
Power Level:	0.0 dBmV			
Signal to Noise Ratio:	0.0 dBmV			
Channel 7:				
Channel ID:	Hot used			
Downstream Frequency:	0 Hz			
Modulation:	unknown			
Power Level:	0.0 dBmV			
Signal to Noise Ratio:	0.0 dBmV			
Channel 8:				
Channel ID:	Hot used			

Upstream Channels Section Example

The screenshot displays the 'Upstream Channels' section of a monitoring interface. It features a central table with 8 channels, each showing its status and various parameters. The status for all channels is 'Not used'. The parameters listed for each channel are Downstream Frequency (0 Hz), Modulation (unknown), Power Level (0.0 dBm), and Signal to Noise Ratio (0.0 dBm). A 'Refresh' button is located at the bottom right of the interface.

Channel ID	Downstream Frequency	Modulation	Power Level	Signal to Noise Ratio
Channel 5	0 Hz	unknown	0.0 dBm	0.0 dBm
Channel 6	0 Hz	unknown	0.0 dBm	0.0 dBm
Channel 7	0 Hz	unknown	0.0 dBm	0.0 dBm
Channel 8	0 Hz	unknown	0.0 dBm	0.0 dBm

Channel ID	Upstream Frequency	Modulation	Bit Rate	Power Level
Channel 1	0	0 QAM	0 kBits/sec	0.0 dBm
Channel 2	0	0 QAM	0 kBits/sec	0.0 dBm
Channel 3	0	0 QAM	0 kBits/sec	0.0 dBm
Channel 4	0	0 QAM	0 kBits/sec	0.0 dBm

Status DOCSIS Signal Page Description

Section	Field Description
Downstream Channels	Channel ID Displays the channel ID.
	Downstream Frequency Displays the downstream frequency in Hz.
	Modulation Displays one of the following modulation types currently in use: QPSK, 8 QAM, 16 QAM, 32 QAM, 64 QAM, or 128 QAM
	Power Level Displays the input level of the CMTS carrier in dBm.

Section	Field Description
	<p>Signal to Noise Ratio Displays the signal to noise ratio in dBmv.</p>
Upstream Channels	<p>Channel ID Displays the channel ID.</p>
	<p>Upstream Frequency Displays the upstream frequency in Hz.</p>
	<p>Modulation Displays one of the following modulation types currently in use: QPSK, 8 QAM, 16 QAM, 32 QAM, 64 QAM, or 128 QAM</p>
	<p>Bit Rate Displays the Bit Rate in kBits/sec.</p>
	<p>Power Level Displays the upstream power level in dBmv.</p>

Status > DOCSIS Status

Important: This page is only visible until the gateway goes online. After the gateway is online and registered on the network, this page is no longer visible.

The DOCSIS Status page displays a detailed status report of the DOCSIS status, Ethernet link status for each interface, QoS status, and configuration parameters for the residential gateway.

Select the **DOCSIS Status** tab to open the Status DOCSIS Status page.

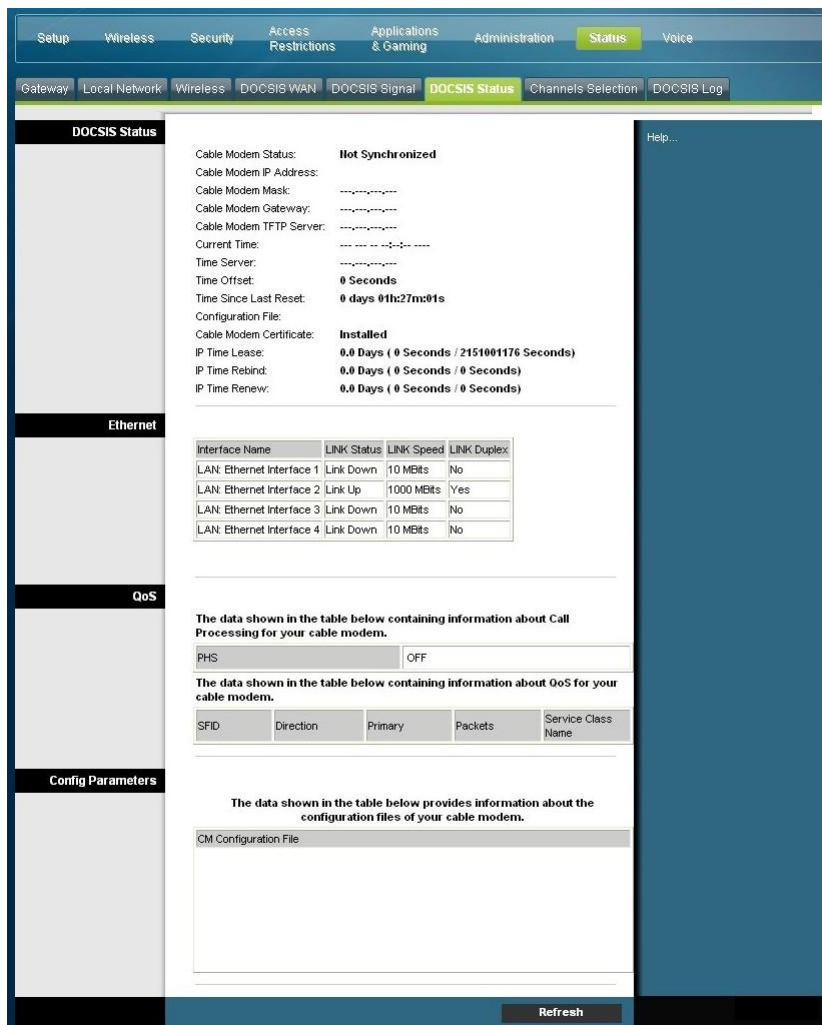

DOCSIS Status Page Description

Use the descriptions in the following table to review the items shown in the DOCSIS Status page.

Section	Field Description
DOCSIS Status	<p data-bbox="586 264 841 289">Cable Modem Status</p> <p data-bbox="586 310 1273 373">Displays one of the following possible current states of the gateway:</p> <ul data-bbox="586 394 922 1014" style="list-style-type: none"> <li data-bbox="586 394 699 420">■ other <li data-bbox="586 441 748 466">■ notReady <li data-bbox="586 487 837 512">■ notSynchronized <li data-bbox="586 533 846 558">■ phySynchronized <li data-bbox="586 579 906 604">■ usParametersAcquired <li data-bbox="586 625 846 651">■ rangingComplete <li data-bbox="586 672 773 697">■ ipComplete <li data-bbox="586 718 808 743">■ todEstablished <li data-bbox="586 764 862 789">■ securityEstablished <li data-bbox="586 810 922 835">■ psrsmTransferComplete <li data-bbox="586 856 886 882">■ registrationComplete <li data-bbox="586 903 773 928">■ operational <li data-bbox="586 949 792 974">■ accessDenied <hr/> <p data-bbox="586 1035 899 1060">Cable Modem IP Address</p> <p data-bbox="586 1081 1105 1106">Displays the IP address of the cable modem.</p> <hr/> <p data-bbox="586 1127 834 1152">Cable Modem Mask</p> <p data-bbox="586 1173 1105 1199">Displays the IP subnet mask of the gateway.</p> <hr/> <p data-bbox="586 1220 873 1245">Cable Modem Gateway</p> <p data-bbox="586 1266 1049 1291">Displays the IP address of the gateway.</p> <hr/> <p data-bbox="586 1312 919 1337">Cable Modem TFTP Server</p> <p data-bbox="586 1358 1256 1383">Displays the IP address of the cable modem TFTP server.</p> <hr/> <p data-bbox="586 1404 753 1430">Current Time</p> <p data-bbox="586 1451 891 1476">Displays the current time.</p> <hr/> <p data-bbox="586 1497 737 1522">Time Server</p> <p data-bbox="586 1543 1297 1606">Displays the IP address of the Network Time Protocol (NTP) server.</p> <hr/> <p data-bbox="586 1627 737 1652">Time Offset</p> <p data-bbox="586 1673 1235 1698">Displays the offset from Greenwich Mean Time (GMT).</p> <hr/> <p data-bbox="586 1719 854 1745">Time Since Last Reset</p> <p data-bbox="586 1766 1383 1829">Displays the number of days, hours, minutes, and seconds since the device was reset.</p>

Section	Field Description
	<p>Configuration File</p> <p>Displays the name of the configuration file currently in use.</p>
	<p>Cable Modem Certificate</p> <p>Displays whether the cable modem certificate is installed or not installed.</p>
	<p>IP Time Lease</p> <p>Displays the time remaining in the IP address lease.</p>
	<p>IP Time Rebind</p> <p>Displays the time remaining in the IP address lease.</p>
	<p>IP Time Renew</p> <p>Displays the length of time to elapse before the gateway retries DHCP requests.</p>
Ethernet	<p>Interface Name</p> <p>LAN: Ethernet Interface 1 through 4.</p>
	<p>LINK Status 1</p> <p>Displays whether the port is connected (Link Up) or not connected (Link Down).</p>
	<p>LINK Speed</p> <p>Displays the connection speed of the connected port (in Mbits).</p>
	<p>LINK Duplex</p> <p>Displays whether the port is operating in a bidirectional mode.</p>
QoS	<p>PHS</p> <p>Displays the Payload Header Suppression.</p>
	<p>SFID</p> <p>Displays the Service Flow ID.</p>
	<p>Direction</p> <p>Indicates whether the direction is upstream or downstream.</p>
	<p>Primary</p> <p>Indicates whether this is the primary service flow or the secondary service flow.</p>
	<p>Packets</p> <p>Displays the number of packets.</p>
	<p>Service Class Name</p> <p>Displays the name of the service class.</p>

Section	Field Description
Config Parameters	<p>Configuration File</p> <p>Shows information about the configuration files of your cable modem.</p>

Status > Channels Selection

Important: This page is only visible until the gateway goes online. After the gateway is online and registered on the network, this page is no longer visible.

Select the **Channels Selection** tab to open the Status Channels Selection page.

Section	Field Description
Channels Selection	<p>Scan</p> <p>Displays the description of the page.</p>
	<p>Present Downstream Frequency</p> <p>Displays the present downstream frequency to which the cable is tuned at this time.</p>

Section	Field Description
	<p>Upstream channel ID</p> <p>Displays the upstream channel ID. Click Submit to set the Upstream channel ID.</p>
	<p>Frequency Start Value</p> <p>This field allows you to modify the frequency at which the cable modem starts its scan during installation and registration. Enter the new start frequency and restart the modem.</p> <p>Click the large button available in this section to restart your cable modem.</p>
	<p>Upstream Channel Setting</p> <p>This field allows you to modify the channel that the cable modem will use. Enter the new channel and restart the modem.</p> <p>Click the large button available in this section to restart your cable modem.</p>

Status > DOCSIS Log

Important: This page is only visible until the gateway goes online. After the gateway is online and registered on the network, this page is no longer visible.

The Status DOCSIS Log page allows you to view the DOCSIS log.

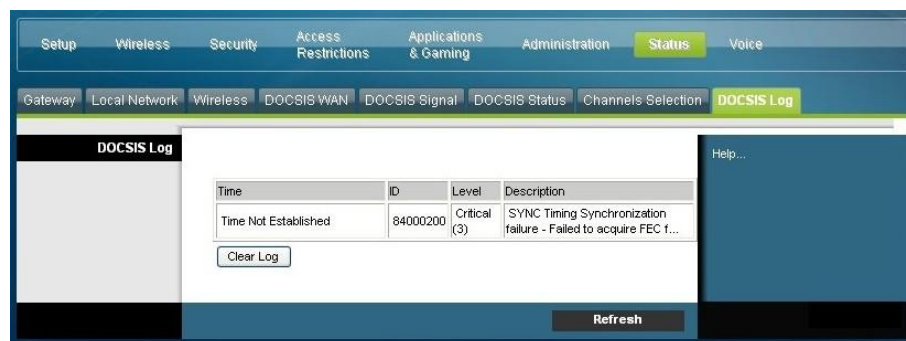

DOCSIS Log Page Description

Use the descriptions in the following table to review the items shown in the DOCSIS Log page.

Section	Field Description
DOCSIS Log	<p>Time</p> <p>Displays the time of the event.</p>
	<p>ID</p> <p>Displays a unique numeric value assigned to the event.</p>

Monitor Gateway Status

Section	Field Description
	Level Displays the type and severity of the event.
	Description Displays a detailed description of the event.
	Clear Log Click to clear the entries in the log.
	Refresh Click to refresh the log and obtain updated information.

Configure Wireless Settings

This section describes the options available from the Wireless pages that you can use to configure the parameters of the WAP to meet your specific requirements and needs.

Wireless > Basic Settings

Setting up your residential gateway for wireless communication provides you with the freedom to connect to the Internet from any location within range of the WAP without having to use wired connections. Select the **Basic Settings** tab to open the Wireless Basic Settings page.

The Wireless Basic Settings page allows you to choose your wireless network mode and other basic features.

- Wireless Network: Enable or Disable
- Wireless Configuration: Manual or Wi-Fi Protected Setup (WPS)
- Network Mode
- Radio Band
- Channel Width
- Standard Channel
- Wireless Network Name (SSID)

Wireless Configuration Manual Page Example

The screenshot displays the 'Basic Settings' page for wireless configuration. The interface includes a navigation menu at the top with options like Setup, Wireless, Security, Access Restrictions, Applications & Gaming, Administration, Status, and Log Off. Below this, there are sub-tabs for Basic Settings, Wireless Security, MAC Filter, Advanced Settings, WDS Settings, and QoS. The main content area is titled 'Basic Settings' and contains the following configuration options:

- Wireless Network: Enable Disable
- Wireless Configuration: Manual Wi-Fi Protected Setup
- Network Mode: B/G/N Mixed (dropdown)
- Radio Band: Enabled 2.4GHz (dropdown)
- Channel Width: Standard - 20 MHz Channel (dropdown)
- Standard Channel: Auto (dropdown)

Below these settings is a table for the Wireless Network Name (SSID):

Wireless Network Name (SSID)	BSSID	Broadcast SSID	Enable
ced875	00:22:CE:7B:D9:EC	<input checked="" type="checkbox"/>	<input checked="" type="checkbox"/>

At the bottom of the page, there are two buttons: 'Save Settings' and 'Cancel Changes'.

Wireless Basic Settings Page Description

Use the following table to configure the basic settings for wireless communication for the residential gateway. After you make your selections, click **Save Settings** to apply your changes or **Cancel Changes** to cancel.

Section	Field Description
Basic Settings	<p data-bbox="568 420 1367 514">Wireless Network Enable or Disable the wireless network.</p> <hr/> <p data-bbox="568 514 1367 892">Wireless Configuration The default is WPS. Select Wi-Fi Protected Setup to set up your network using this option. The Wi-Fi Protected Setup feature automatically configures an encryption-secured, wireless network. To use Wi-Fi Protected Setup, you must have at least one other device that supports Wi-Fi Protected Setup in your network. After you have configured your Wi-Fi Protected Setup devices, you can manually configure other devices . See Wi-Fi Protected Setup (WPS) for more information about using WPS.</p> <hr/> <p data-bbox="568 892 1367 1123">Network Mode Choose one of these options for the network mode: G only, B/G Mixed, B/G/N Mixed (factory default) Important: When TKIP authentication only is selected, B/G/N Mixed network mode is not available.</p> <hr/> <p data-bbox="568 1123 1367 1302">Radio Band Select Enabled 2.4 GHz (factory default) or Enabled 5 GHz. Note: The 5 GHz radio band may not be supported on some models.</p> <hr/> <p data-bbox="568 1302 1367 1396">Channel Width Choose Standard - 20 MHz Channel or Wide 40 MHz Channel.</p> <hr/> <p data-bbox="568 1396 1367 1591">Standard Channel Select one of the channels from the drop-down list to correspond with your network settings. All devices in your wireless network must broadcast on the same channel in order to communicate. You can select Auto (factory default) for automatic channel selection.</p>

Wireless Network Name (SSID)

The SSID is the name of your wireless network. The SSID is used by wireless technology to identify your network from other wireless networks in the area. The SSID can be up to 32 characters long. The factory default SSID is typically the last 6 characters of the CM MAC address found on the rating label located on the bottom of your gateway.

This SSID is a unique identity and does not need to be changed unless you choose to do so. Your service provider may provide you with wireless setup information that may call for a different SSID.

BSSID

Displays the Basic Service Set Identifier (BSSID) of your wireless network. The BSSID is typically the MAC Address of the wireless access point.

Note: This may not be the same MAC Address as the CM MAC Address used to determine the factory default SSID.

Broadcast SSID

When this box is checked (factory default), the gateway transmits or advertises its presence to other wireless devices. Client devices can automatically detect the access point when this beacon is enabled.

Uncheck this box if you want to hide your network from wireless clients. If you hide your network, you will need to configure each of your wireless client devices manually.

Important: The **Enable** check box is not currently in use and does not impact operation of the gateway.

Wireless > Wireless Security

Selecting a wireless security mode helps protect your network. If you select **Disable**, then your wireless network is not secure and any wireless device within range may connect to it.

To keep intruders out of your wireless network, use the Wireless Security page to configure your security parameters including SSID, the security mode, and your encryption keys.

Select the **Wireless Security** tab to open the Wireless Security page. The following illustrations show examples of the Wireless Security page.

Wireless Security Page Description

Use the following table to configure the wireless security for the residential gateway. After you make your selections, click **Save Settings** to apply your changes or **Cancel Changes** to cancel.

Section	Field Description
Wireless Security	Wireless Security Mode

Choose one of these options for the security mode:

WEP

Wired Equivalent Privacy (WEP) security mode is defined in the original IEEE 802.11 standard. This mode is no longer recommended because of its weak security protection. Users are urged to migrate to either WPA-Personal or WPA2-Personal.

Note: WPS mode does not support WEP on this device.

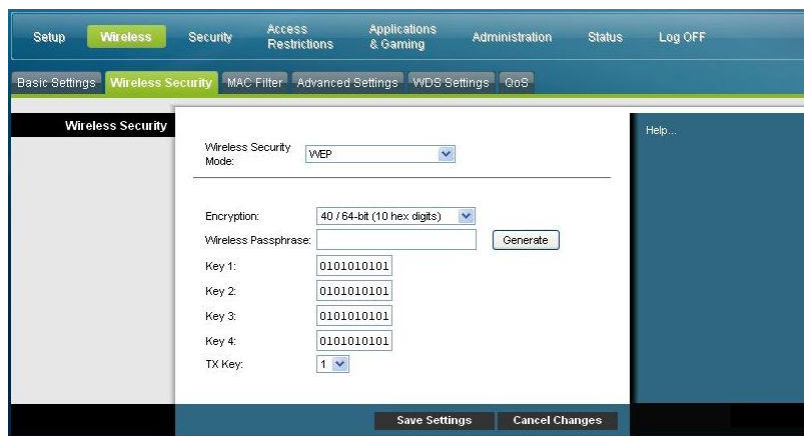

Field Descriptions

- **Encryption.** Select a level of WEP encryption, 40 / 64 bits (10 hex digits) or 104 / 128 bits (26 hex digits).
- **Wireless Passphrase.** To complete your wireless security setup, you should choose a wireless passphrase that is easy for you to remember and hard for anyone else to guess. The first time you connect a new wireless device to this network, you may need to enter this passphrase into the appropriate setup section in the connected device. To improve your network security, do not give out this passphrase to unauthorized users. Please enter a phrase of letters and/or numbers from 4 to 24 digits long. Then, click **Generate** to create the Passphrase.
- **Key 1-4.** If you want to manually enter WEP keys, then complete the fields provided. Each WEP key can consist of the letters A through F and the numbers 0 through 9. It should be 10 characters in length for 40/64-bit encryption or 26 characters in length for 104/128-bit encryption.
- **TX Key.** Choose a Transmit (TX) Key from 1 to 4. The TX key is the key that will be used to encrypt your data. Although four keys can be created, only one key is used for encrypting data. Select one of the four keys for WEP encryption. Use the selected TX key to set up your wireless clients.

Section	Field Description
---------	-------------------

WPA

Security for Personal Networks - WPA or WPA2 Personal Modes

Wi-Fi Protected Access (WPA) is a more secure wireless technology than WEP. WPA can be used for both Enterprise (corporate applications) and Personal (home network) wireless networks. We strongly recommend that you select either WPA-Personal or WPA2-Personal as the security mode for your home network, depending on which mode is supported by the wireless adapter in your PC or wireless clients.

WPA-Personal (aka WPA-PSK or WPA-Pre-Shared Key), provides a more secure wireless network than WEP. WPA-Personal introduces TKIP user authentication and stronger encryption keys than WEP.

WPA2-Personal (aka WPA2-PSK or WPA2-Pre-Shared Key) provides the most secure standards-based wireless networking. WPA2-Personal incorporates AES (Advanced Encryption Standard) for data transmission.

Note: Not all wireless adapters support WPA2. WPA is supported across a wider range of devices. Whether you use WPA or WPA2, make sure to use a “strong” passphrase. A strong passphrase is a string of random characters at least 21 characters in length.

Select from one of the following three WPA or WPA2-Personal modes:

- **WPA-Personal**
- **WPA2-Personal**
- **WPA or WPA2-Personal**

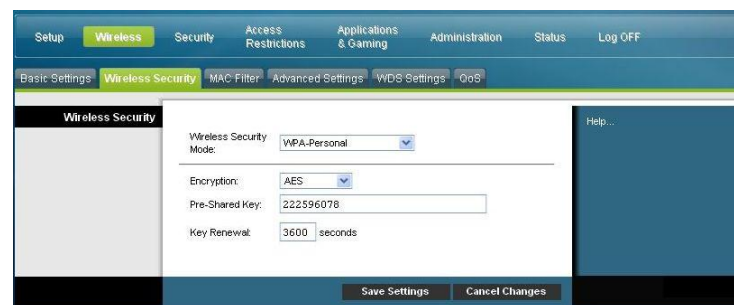

Field Descriptions

- **Encryption.** The default is **TKIP + AES**.
- **Pre-Shared Key.** Enter a key of 8 to 63 characters.
- **Key Renewal.** Enter a Key Renewal period, which instructs the device how often it should change encryption keys. The default is **3600** seconds.

Section	Field Description
---------	-------------------

Security for Enterprise Networks - WPA-Enterprise Modes

This option features WPA used in coordination with a RADIUS server for client authentication. (This should only be used when a RADIUS server is connected to the device.)

Select from one of the following three WPA or WPA2-Enterprise modes:

- **WPA-Enterprise**
- **WPA2-Enterprise**
- **WPA or WPA2-Enterprise**

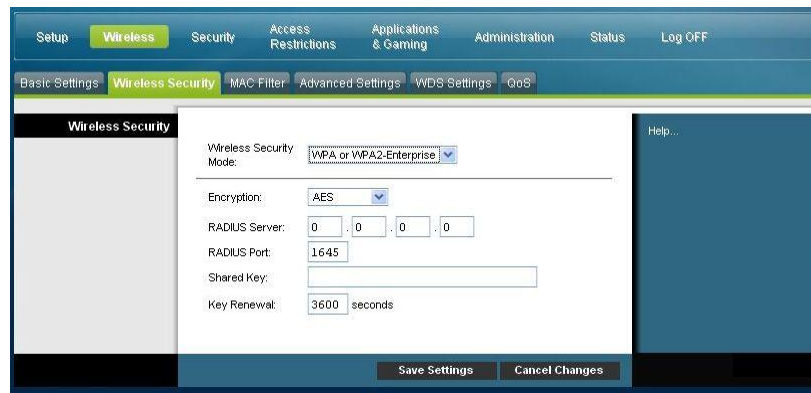

Field Description

- **Encryption.** The default is **TKIP + AES**.
- **RADIUS Server.** Enter the RADIUS server's IP address.
- **RADIUS Port.** Enter the port number used by the RADIUS server. The default is **1812**.
- **Shared Key.** Enter the key used by the device and RADIUS server.
- **Key Renewal.** Enter a Key Renewal period, which instructs the device how often it should change encryption keys. The default is **3600** seconds.

Wireless > MAC Filter

The MAC Filter feature is used to either allow or block access to your wireless LAN based on the MAC Address of the wireless client devices. The MAC Filter feature, also known as an access list, can be used to help protect your wireless network from access by unauthorized users.

Select the **MAC Filter** tab to open the Wireless MAC Filter page.

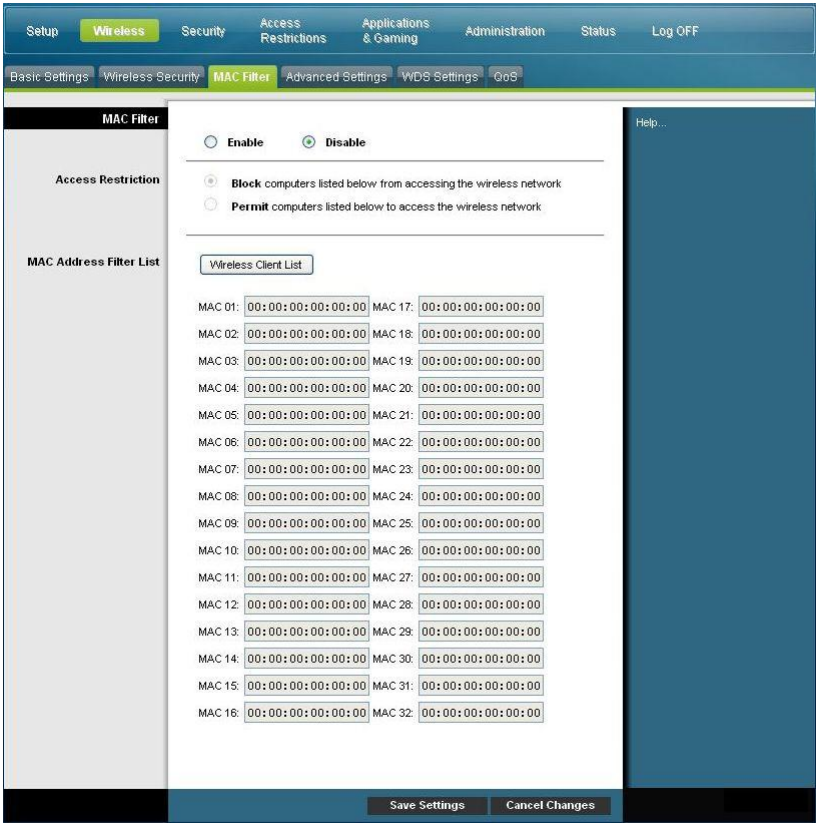

Wireless MAC Filter Page Description

Use the descriptions and instructions in the following table to configure the MAC address filtering for the wireless network for your residential gateway. After you make your selections, click **Save Settings** to apply your changes or **Cancel Changes** to cancel.

Section	Field Description
MAC Filter	Allows you to Enable or Disable MAC Filtering for the residential gateway.

Section	Field Description
Access Restriction	<p data-bbox="634 264 857 289">Access Restriction</p> <p data-bbox="634 312 1344 443">Allows you to permit or block computers from accessing the wireless network. The choice that you make here affects the addresses listed on this page. Choose one of the following options:</p> <ul data-bbox="634 464 1377 768" style="list-style-type: none"> <li data-bbox="634 464 1357 590">■ Block computers listed below from accessing the wireless network. Select this option to deny Internet access to the MAC addresses of the devices you list in the table. All other MAC addresses will be allowed Internet access. <li data-bbox="634 611 1377 768">■ Permit computers listed below access to the wireless network. Select this option to allow Internet access only to the MAC addresses of the devices you list in the table. Any MAC addresses not listed in the table will be denied Internet access
MAC Address FilterList	<p data-bbox="634 789 935 814">MAC Address Filter List</p> <p data-bbox="634 837 1377 1037">The MAC Address Filter List displays users whose wireless access you want to control. Click Wireless Client List to display a list of network users by MAC address. From the To Sort by drop-down menu, you can sort the table by IP Address, MAC Address, Status, Interface, or Client Name. To view the most up-to-date information, click the Refresh button.</p>

Wireless > Advanced Settings

Your advanced wireless settings add another layer of security to the wireless network for your residential gateway. This page is used to set up the advanced wireless functions. Only an expert administrator should adjust these settings. Incorrect settings can reduce wireless performance.

Select the **Advanced Settings** tab to open the Wireless Advanced Settings page.

Use this page to configure the following options:

- N Transmission Rate
- CTS Protection Mode
- Beacon Interval
- DTM Interval
- Fragmentation Threshold

■ RTS Threshold

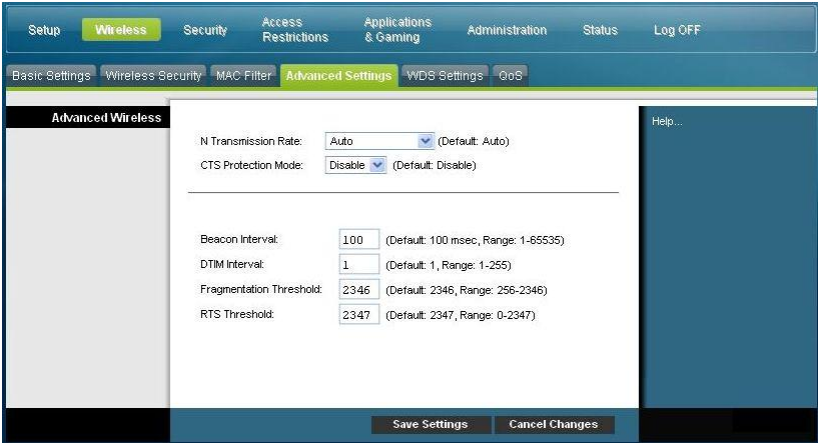

Wireless Advanced Settings Page Description

Use the descriptions and instructions in the following table to configure the advanced wireless settings for your residential gateway. After you make your selections, click **Save Settings** to apply your changes or **Cancel Changes** to cancel.

Section	Field Description
Advanced Wireless	<p data-bbox="597 254 852 289">N Transmission Rate</p> <p data-bbox="597 310 1383 541">The rate of data transmission should be set depending on the speed of your Wireless-N networking. Select from a range of transmission speeds, or select Auto to have the device automatically use the fastest possible data rate and enable the Auto-Fallback feature. Auto-Fallback negotiates the best possible connection speed between the device and a wireless client. The default setting is Auto.</p> <p data-bbox="597 562 1279 598">Choose one of the following options for transmission rate:</p> <ul data-bbox="597 609 893 1480" style="list-style-type: none"><li data-bbox="597 609 893 644">■ Auto (factory default)<li data-bbox="597 655 893 690">■ Use Legacy Rate<li data-bbox="597 701 893 737">■ 0: 6.5 or 13.5 Mbps<li data-bbox="597 747 893 783">■ 1: 13 or 27 Mbps<li data-bbox="597 793 893 829">■ 2: 19.5 or 40.5 Mbps<li data-bbox="597 840 893 875">■ 3: 26 or 54 Mbps<li data-bbox="597 886 893 921">■ 4: 39 or 81 Mbps<li data-bbox="597 932 893 968">■ 5: 52 or 108 Mbps<li data-bbox="597 978 893 1014">■ 6: 58.5 or 121.5 Mbps<li data-bbox="597 1024 893 1060">■ 7: 65 or 135 Mbps<li data-bbox="597 1071 893 1106">■ 8: 13 or 27 Mbps<li data-bbox="597 1117 893 1152">■ 9: 26 or 54 Mbps<li data-bbox="597 1163 893 1199">■ 10: 39 or 81 Mbps<li data-bbox="597 1209 893 1245">■ 11: 52 or 108 Mbps<li data-bbox="597 1255 893 1291">■ 12: 78 or 162 Mbps<li data-bbox="597 1302 893 1337">■ 13: 104 or 216 Mbps<li data-bbox="597 1348 893 1383">■ 14: 117 or 243 Mbps<li data-bbox="597 1394 893 1430">■ 15: 130 or 270 Mbps <hr/> <p data-bbox="597 1491 860 1526">CTS Protection Mode</p> <p data-bbox="597 1547 1383 1778">CTS (Clear-To-Send) Protection Mode boosts the device's ability to catch all wireless transmissions, but can severely decrease performance. Select Auto if you want the device to use this feature as needed, when the Wireless-N/G products are not able to transmit to the device in an environment with heavy 802.11b traffic. Select Disable if you want to permanently disable this feature.</p>

Beacon Interval

The Beacon Interval value indicates the frequency interval of the beacon. A beacon is a packet broadcast by the device to synchronize the wireless network.

(Default: 100 msec, Range: 20-1000)

DTIM Interval

The Delivery Traffic Indication Message (DTIM) indicates the interval between Broadcasts/Multicast transmissions. DTIM field is a countdown field informing clients of the next window for listening to broadcast and multicast messages. When the device has buffered broadcast or multicast messages for associated clients, it sends the next DTIM with a DTIM Interval value. Its clients hear the beacons and awaken to receive the broadcast and multicast messages.

(Default: 1, Range: 1-255)

Fragmentation Threshold

The fragmentation threshold value specifies the maximum size for a packet before data is fragmented into multiple packets. If you experience a high packet error rate, you may slightly increase the Fragmentation Threshold. Setting the Fragmentation Threshold too low may result in poor network performance. Only minor reduction of the default value is recommended. In most cases, it should remain at its default value of 2346.

RTS Threshold

The RTS Threshold determines at what packet size beyond which the ready to send/clear to send (RTS/CTS) mechanism is invoked. Should you encounter inconsistent data flow, only minor reduction of the default value, 2346, is recommended. If a network packet is smaller than the preset RTS Threshold size, the RTS/CTS mechanism will not be enabled. The device sends Request to Send (RTS) frames to a particular receiving station and negotiates the sending of a data frame. After receiving an RTS, the wireless station responds with a Clear to Send (CTS) frame to acknowledge the right to begin transmission. The RTS Threshold value should remain at its default value of 2347.

Wireless > WDS Settings

The Wireless Distribution System (WDS) Settings page allows you to expand the coverage of your wireless network by deploying signal repeaters. Make sure the channel settings are the same for all WDS enabled devices.

Configure Wireless Settings

Select the **WDS Settings** tab to open the Wireless WDS Settings page. Use this page to configure the WDS settings.

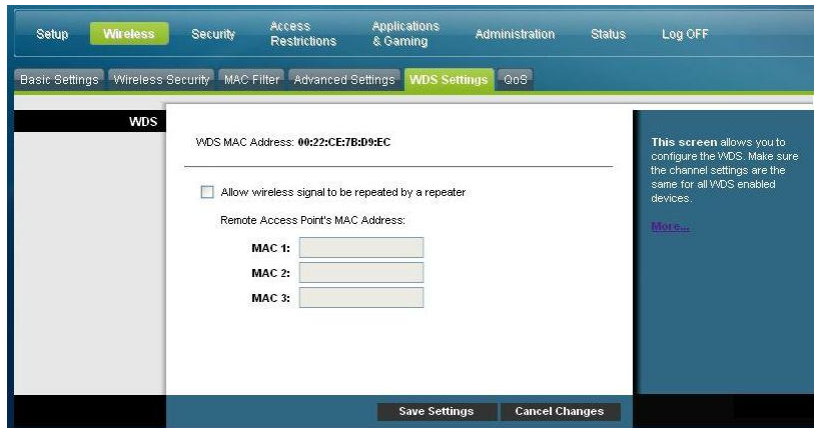

The screenshot shows a web interface for configuring WDS settings. At the top, there is a navigation bar with tabs: Setup, Wireless (selected), Security, Access Restrictions, Applications & Gaming, Administration, Status, and Log OFF. Below this is a sub-navigation bar with tabs: Basic Settings, Wireless Security, MAC Filter, Advanced Settings, WDS Settings (selected), and QoS. The main content area is titled 'WDS' and contains the following fields and controls:

- WDS MAC Address: 00:22:CE:7B:D9:EC
- Allow wireless signal to be repeated by a repeater
- Remote Access Point's MAC Address:
 - MAC 1: [text input field]
 - MAC 2: [text input field]
 - MAC 3: [text input field]

At the bottom right, there is a blue sidebar with the text: "This screen allows you to configure the WDS. Make sure the channel settings are the same for all WDS enabled devices." and a link "More...". At the bottom center, there are two buttons: "Save Settings" and "Cancel Changes".

Wireless WDS Settings Page Description

Use the descriptions and instructions in the following table to configure the wireless distribution system settings for your residential gateway. After you make your selections, click **Save Settings** to apply your changes or **Cancel Changes** to cancel.

Section	Field Description
WDS	WDS MAC Address Displays the WDS MAC Address (or BSSID) of your gateway access point.
	Allow Wireless Signal To Be Repeated by a Repeater Check this box to allow a wireless client to connect to a repeater and route traffic between the wireless client and a repeater. A maximum of 3 repeaters are allowed.
	Remote Access Point's MAC Address (MAC 1 through 3) Use the three fields (MAC 1, 2, and 3) to enter the MAC address of the repeaters.

Configure Applications and Gaming

Overview

Most well-known Internet applications are supported by Application Layer Gateways (ALGs). ALGs automatically adjust the gateway firewall to allow data to pass without making any custom settings. We recommend that you test your application before making changes in this section.

Applications & Gaming > Port Filtering

Use this window to configure transmission control protocol (TCP) and user datagram protocol (UDP) port filters. These filters prevent a range of TCP/UDP ports from accessing the Internet. You can also prevent PCs from sending outgoing TCP/UDP traffic to the WAN on specific IP port numbers. This filter is not IP address- or MAC address- specific. The system blocks the specified port ranges for all PCs.

Select the **Port Filtering** tab to open the Applications & Gaming Port Filtering page.

Start Port	End Port	Protocol	Enable
0	0	Both	<input type="checkbox"/>
0	0	Both	<input type="checkbox"/>
0	0	Both	<input type="checkbox"/>
0	0	Both	<input type="checkbox"/>
0	0	Both	<input type="checkbox"/>
0	0	Both	<input type="checkbox"/>
0	0	Both	<input type="checkbox"/>
0	0	Both	<input type="checkbox"/>
0	0	Both	<input type="checkbox"/>
0	0	Both	<input type="checkbox"/>
0	0	Both	<input type="checkbox"/>

Applications and Gaming Port Filtering Page Description

Use the descriptions and instructions in the following table to configure the port filtering for applications and gaming features used on your residential gateway. Click the **Enable** checkbox to enable port forwarding for the relevant application. After you make your selections, click **Save Settings** to apply your changes or **Cancel Changes** to cancel.

Section	Field Description
Port Filtering	Start Port:
	This is the beginning of the port range. Enter the beginning of the range of port numbers (external ports) used by the server or Internet application. Check with the software documentation of the Internet application for more information if necessary.
	End Port:
	This is the end of the port range. Enter the end of the range of port numbers (external ports) used by the server or Internet application. Check with the software documentation of the Internet application for more information if necessary.
	Protocol
	Select one of the following protocols:
	■ TCP
	■ UDP
	■ Both
	Enable:
	Allows you to enable port filtering.

Applications & Gaming > Port Range Forwarding

Important: The gateway normally implements a feature called Port Translation. Port Translation monitors what ports are actually being used by your PCs or other devices on your LAN. This monitoring provides an added level of security beyond what the firewall provides. However, there are some applications that require the gateway to use specific ports to connect over the Internet.

Use Port Range Forwarding to forward ports to specific IP addresses as the page name implies. Select the **Port Range Forwarding** tab to open the Applications & Gaming Port Range Forwarding page.

For the Start and End Port, select a port from the recommended 49152 - 65535 range. Keep in mind that ports used are program specific so check which ones the program requires to be forwarded. Type the port number or range in both boxes. In the IP Address box, type the name of the computer's IP address to which this applies.

Note: Port Range Forwarding continually exposes the selected ports to the public Internet. This means that the gateway's firewall is no longer active on these ports. The device with the forwarding IP address can be exposed to hacker attacks while the port range is being forwarded.

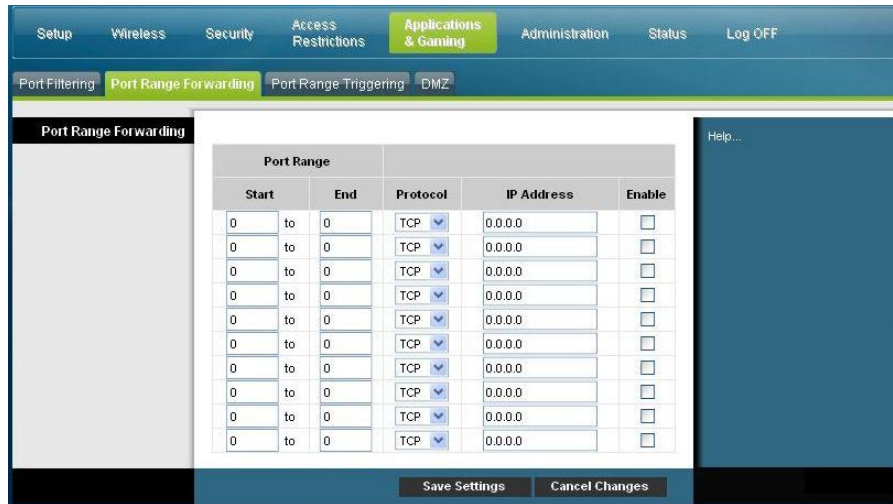

Applications and Gaming Port Range Forward Page Description

Use the descriptions and instructions in the following table to configure the port range forwarding for the residential gateway. Select enable for each. After you make your selections, click **Save Settings** to apply your changes or **Cancel Changes** to cancel.

Section	Field Description
Port Range Forwarding	Start
	End
	Protocol
	IP Address

For the Start port, select a port from the recommended 49152 - 65535 range. Keep in mind that ports used are program specific so check which ones the program requires to be forwarded.

End

For the End port, select a port from the recommended 49152 - 65535 range. Keep in mind that ports used are program specific so check which ones the program requires to be forwarded.

Protocol

Select one of the following protocols:

- TCP
- UDP
- Both

IP Address

Enter the computer's IP address to which this applies.

Section	Field Description
	Enable
	Check this box to enable port forwarding for the specified ports and IP addresses.

Applications & Gaming > Port Range Triggering

Port range triggering is a way to dynamically forward ports to a LAN PC that needs them at a particular time. That particular time is when it runs a certain application that performs some event that triggers the router. This event must be an outbound access of a particular port range.

Select the **Port Range Triggering** tab to open the Applications & Gaming Port Range Triggering page.

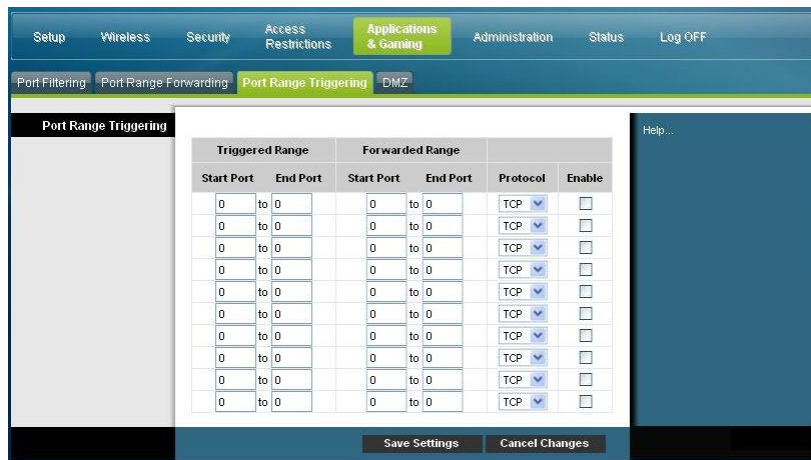

Applications and Gaming Port Range Triggering Page Description

Use the descriptions and instructions in the following table to configure the port range triggering for the residential gateway. Select enable for each. After you make your selections, click **Save Settings** to apply your changes or **Cancel Changes** to cancel.

Section	Field Description
Port Range Triggering	
Triggered Range	Start Port
	For the Start port, select a port from the recommended 49152 - 65535 range. Keep in mind that ports used are program specific so check which ones the program requires to be forwarded.
	End Port
	For the End port, select a port from the recommended 49152 - 65535 range. Keep in mind that ports used are program specific so check which ones the program requires to be forwarded.

Section	Field Description
Forwarded Range	Start Port
	For the Start port, select a port from the recommended 49152 - 65535 range. Keep in mind that ports used are program specific so check which ones the program requires to be forwarded.
	End Port
	For the End port, select a port from the recommended 49152 - 65535 range. Keep in mind that ports used are program specific so check which ones the program requires to be forwarded.
	Protocol
	Select one of the following protocols:
	■ TCP
	■ UDP
	■ Both
	Enable
	Click the Enable checkbox to enable port range triggering for the relevant application.

Applications & Gaming > DMZ

Use this page to configure an IP address whose ports are directly exposed to the public Internet or to the Wide Area Network (WAN). Demilitarized Zone (DMZ) hosting is commonly referred to as "exposed host," and allows you to specify a recipient of WAN traffic that Network Address Translation (NAT) is unable to translate to a known local PC.

A DMZ is typically used by a company that wants to host its own Internet server. DMZ allows one IP address to be placed on the Internet side of the gateway firewall while others remain protected behind the firewall.

Configure Applications and Gaming

The DMZ allows a device to be directly accessible to Internet traffic, such as a web (HTTP) server, an FTP server, an SMTP (e-mail) server, and a domain name system (DNS) server. Select the **DMZ** tab to open the Applications & Gaming DMZ page.

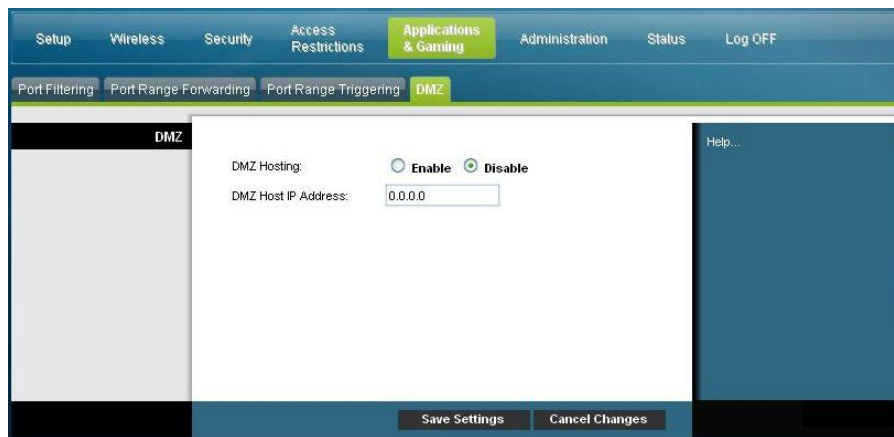

Applications and Gaming DMZ Page Description

Use the descriptions and instructions in the following table to configure the port range triggering for the residential gateway. Select enable for each DMZ Host IP address. After you make your selections, click **Save Settings** to apply your changes or **Cancel Changes** to cancel.

Section	Field Description
DMZ	DMZ Hosting Select the desired option: <ul style="list-style-type: none">■ Enable■ Disable (factory default)
	DMZ Host IP Address DMZ allows one IP address to be unprotected while others remain protected. Enter the IP address of the computer you want to expose to the Internet in this field.

Applications & Gaming > QoS

Quality of Service (QoS) ensures better service to high-priority types of network traffic, which may involve demanding, real-time applications, such as video conferencing. QoS settings allow you to specify priorities for different types of traffic. Lower priority traffic will be slowed down to allow greater throughput or less delay for high priority traffic.

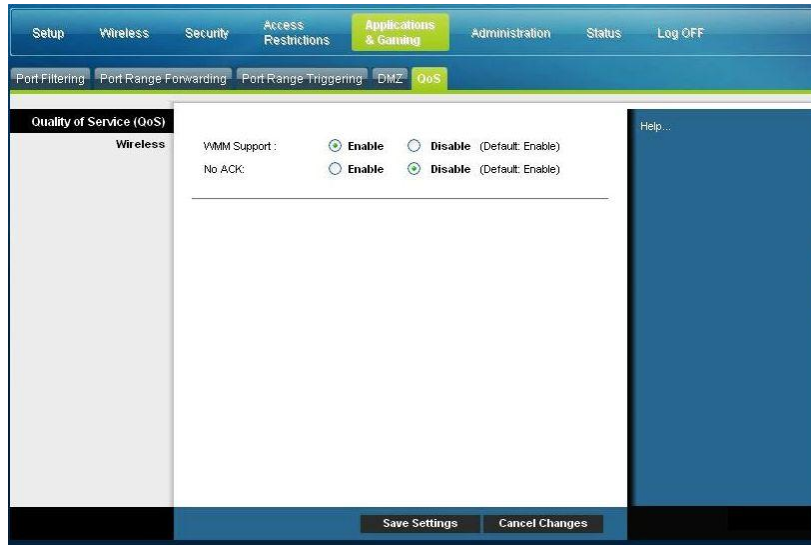

Use the following table to configure the port range triggering for the residential gateway. Select enable for each feature you want to enable. After you make your selections, click **Save Settings** to apply your changes or **Cancel Changes** to cancel.

Section	Field Description
Quality of Service (QoS)	WMM Support
Wireless	Allows you to enable or disable Wi-Fi Multimedia (WMM) support. WMM support is enabled by default. If WMM is also supported by your wireless clients, then voice and multimedia traffic will be given higher priority than other traffic
	No ACK
	Allows you to enable or disable No ACK. No ACK is enabled by default. This setting is recommended for voice, for which speed of transmission is important and packet loss is tolerable to a certain degree. If you select Disable , an acknowledge packet is returned for every packet received. This provides a more reliable transmission, but it increases traffic load, which decreases performance.

Having Difficulty?

Q. How Do I Configure TCP/IP Protocol?

A. To configure TCP/IP protocol, you need to have an Ethernet Network Interface Card (NIC) with TCP/IP communications protocol installed on your system. TCP/IP is a communications protocol used to access the Internet. This section contains instructions for configuring TCP/IP on your Internet devices to operate with the residential gateway in Microsoft Windows or Macintosh environments.

TCP/IP protocol in a Microsoft Windows environment is different for each operating system. Follow the appropriate instructions in this section for your operating system.

Configuring TCP/IP on Windows 2000 Systems

- 1 Click **Start**, select **Settings**, and choose **Network and Dial-up Connections**.
- 2 Double-click the **Local Area Connection** icon in the Network and Dial-up Connections window.
- 3 Click **Properties** in the Local Area Connection Status window.
- 4 Click **Internet Protocol (TCP/IP)** in the Local Area Connection Properties window, and then click **Properties**.
- 5 Select both **Obtain an IP address automatically** and **Obtain DNS server address automatically** in the Internet Protocol (TCP/IP) Properties window, and then click **OK**.
- 6 Click **Yes** to restart your computer when the Local Network window opens. The computer restarts. The TCP/IP protocol is now configured on your PC, and your Ethernet devices are ready for use.
- 7 Try to access the Internet. If you cannot access the Internet, contact your service provider for further assistance.

Configuring TCP/IP on Windows XP Systems

- 1 Click **Start**, and depending on your Start menu setup, choose one of the following options:
 - If you are using the Windows XP Default Start Menu, select **Connect to**, choose **Show all connections**, and then go to step 2.
 - If you are using the Windows XP Classic Start Menu, select **Settings**, choose **Network Connections**, click **Local Area Connection**, and then go to step 3.
- 2 Double-click the **Local Area Connection** icon in the LAN or High-Speed Internet section of the Network Connections window.
- 3 Click **Properties** in the Local Area Connection Status window.
- 4 Click **Internet Protocol (TCP/IP)**, and then click **Properties** in the Local Area Connection Properties window.

- 5 Select both **Obtain an IP address automatically** and **Obtain DNS server address automatically** in the Internet Protocol (TCP/IP) Properties window, and then click **OK**.
- 6 Click **Yes** to restart your computer when the Local Network window opens. The computer restarts. The TCP/IP protocol is now configured on your PC, and your Ethernet devices are ready for use.
- 7 Try to access the Internet. If you cannot access the Internet, contact your service provider for further assistance.

Configuring TCP/IP on Macintosh Systems

- 1 Click the **Apple** icon in the upper-left corner of the Finder. Scroll down to **Control Panels**, and then click **TCP/IP**.
- 2 Click **Edit** on the Finder at the top of the page. Scroll down to the bottom of the menu, and then click **User Mode**.
- 3 Click **Advanced** in the User Mode window, and then click **OK**.
- 4 Click the Up/Down selector arrows located to the right of the Connect Via section of the TCP/IP window, and then click **Using DHCP Server**.
- 5 Click **Options** in the TCP/IP window, and then click **Active** in the TCP/IP Options window.
Note: Make sure that the **Load only when needed** option is *unchecked*.
- 6 Verify that the **Use 802.3** option located in the upper-right corner of the TCP/IP window is unchecked. If there is a check mark in the option, uncheck the option, and then click **Info** in the lower-left corner.
- 7 Is there a Hardware Address listed in this window?
 - If **yes**, click **OK**. To close the TCP/IP Control Panel window, click **File**, and then scroll down to click **Close**. You have completed this procedure.
 - If **no**, you must power off your Macintosh.
- 8 With the power off, simultaneously press and hold down the **Command (Apple)**, **Option**, **P**, and **R** keys on your keyboard. Keeping those keys pressed down, power on your Macintosh but do not release these keys until you hear the Apple chime at least three times, then release the keys and let the computer restart.
- 9 When your computer fully reboots, repeat steps 1 through 7 to verify that all TCP/IP settings are correct. If your computer still does not have a Hardware Address, contact your authorized Apple dealer or Apple technical support center for further assistance.

Q. How Do I Renew the IP Address on My PC?

A. If your PC cannot access the Internet after the residential gateway is online, it is possible that your PC did not renew its IP address. Follow the appropriate instructions in this section for your operating system to renew the IP address on your PC.

Renewing the IP Address on Windows 95, 98, 98SE, and ME Systems

- 1 Click **Start**, and then click **Run** to open the Run window.
- 2 Type **winipcfg** in the Open field, and click **OK** to execute the winipcfg command. The IP Configuration window opens.
- 3 Click the down arrow to the right of the top field, and select the Ethernet adapter that is installed on your PC. The IP Configuration window displays the Ethernet adapter information.
- 4 Click **Release**, and then click **Renew**. The IP Configuration window displays a new IP address.
- 5 Click **OK** to close the IP Configuration window. You have completed this procedure.

Note: If you cannot access the Internet, contact your service provider for further assistance.

Renewing the IP Address on Windows NT, 2000, or XP Systems

- 1 Click **Start**, and then click **Run**. The Run window opens.
- 2 Type **cmd** in the Open field and click **OK**. A window with a command prompt opens.
- 3 Type **ipconfig/release** at the C:/ prompt and press **Enter**. The system releases the IP address.
- 4 Type **ipconfig/renew** at the C:/ prompt and press **Enter**. The system displays a new IP address.
- 5 Click the **X** in the upper-right corner of the window to close the Command Prompt window. You have completed this procedure.

Note: If you cannot access the Internet, contact your service provider for further assistance.

Q. What if I don't subscribe to cable TV?

A. If cable TV is available in your area, data service may be made available with or without subscribing to cable TV service. Contact your local service provider for complete information on cable services, including high-speed Internet access.

Q. How do I arrange for installation?

A. Call your service provider to inquire about professional installation. A professional installation ensures proper cable connection to the modem and to your PC, and it ensures the proper configuration of all hardware and software settings. Contact your service provider for more information about installation.

Q. How does the residential gateway connect to my computer?

A. The residential gateway connects to the 1000/100BASE-T Ethernet port on your PC. Ethernet cards available from your local PC or office supply retailer, or from your service provider. For best performance over an Ethernet connection, your PC should be equipped with a Gigabit Ethernet card.

Q. After my residential gateway is connected, how do I access the Internet?

A. Your local service provider becomes your Internet Service Provider (ISP). They offer a wide range of services including e-mail, chat, news, and information services. Your service provider will provide the software you will need.

Q. Can I watch TV and surf the Internet at the same time?

A. Absolutely! If you subscribe to cable television service, you can watch TV and use your residential gateway at the same time by connecting your TV and your residential gateway to the cable network using an optional cable signal splitter.

Q. Can I run more than one device on the modem?

A. Yes. If your service provider permits, a single residential gateway can support up to 63 Ethernet devices utilizing user-supplied Ethernet hubs or routers that you can purchase at your local PC or office supply retailer. Contact your service provider for further assistance.

Troubleshooting MoCA Issues

Q. My MoCA light is not on. What does this mean?

A. There is no other MoCA device connected to your RF cables, or the MoCA device is not turned on. Make sure that the MoCA device is turned on and connected to the RF cable and wait ten minutes. If the light still does not come on, contact your service provider for further assistance.

Common Troubleshooting Issues

I don't understand the front panel status indicators

See *Front Panel LED Status Indicator Functions* (on page 106), for more detailed information on front panel LED status indicator operation and function.

The residential gateway does not register an Ethernet connection

- Verify that your computer has an Ethernet card and that the Ethernet driver software is properly installed. If you purchase and install an Ethernet card, follow the installation instructions very carefully.
- Verify the status of the front panel status indicator lights.

The residential gateway does not register an Ethernet connection after connecting to a hub

If you are connecting multiple PCs to the residential gateway, you should first connect the modem to the uplink port of the hub using the correct crossover cable. The LINK LED of the hub will illuminate continuously.

Having Difficulty?

The residential gateway does not register a cable connection

- The modem works with a standard 75-ohm RF coaxial cable. If you are using a different cable, your residential gateway will not function properly. Contact your cable service provider to determine whether you are using the correct cable.
- Your NIC card may be malfunctioning. Refer to the troubleshooting information in the NIC documentation.

Tips for Improved Performance

Check and Correct

If your residential gateway does not perform as expected, the following tips may help. If you need further assistance, contact your service provider.

- Verify that the plug to your residential gateway AC power is properly inserted into an electrical outlet.
- Verify that your residential gateway AC power cord is not plugged into an electrical outlet that is controlled by a wall switch. If a wall switch controls the electrical outlet, make sure the switch is in the **ON** position.
- Verify that the **ONLINE** LED status indicator on the front panel of your residential gateway is illuminated.
- Verify that your cable service is active and that it supports two-way service.
- Verify that all cables are properly connected, and that you are using the correct cables.
- Verify that your TCP/IP is properly installed and configured if you are using the Ethernet connection.
- Verify that you have called your service provider and given them the serial number and MAC address of your residential gateway.
- If you are using a cable signal splitter so that you can connect the residential gateway to other devices, remove the splitter and reconnect the cables so that the residential gateway is connected directly to the cable input. If the residential gateway now functions properly, the cable signal splitter may be defective and may need to be replaced.
- For best performance over an Ethernet connection, your PC should be equipped with a Gigabit Ethernet card.

Front Panel LED Status Indicator Functions

Initial Power Up, Calibration, and Registration (AC Power applied)

The following chart illustrates the sequence of steps and the corresponding appearance of the residential gateway front panel LED status indicators during power up, calibration, and registration on the network when AC power is applied to the residential gateway. Use this chart to troubleshoot the power up, calibration, and registration process of your residential gateway.

Note: After the residential gateway completes Step 6 (Request High-Speed Data Provisioning File), the modem proceeds immediately to Normal Operations. See *Normal Operations (AC Power applied)* (on page 107).

Front Panel LED Status Indicators During Initial Power Up, Calibration, and Registration							
High Speed Data Registration							
Step:		1	2	3	4	5	6
Front Panel Indicator		Self Test	Downstream Scan	Downstream Signal Lock	Ranging	Requesting IP Address	Request High Speed Data Provisioning File
1	POWER	On	On	On	On	On	On
2	DS	On	Blinking	On	On	On	On
3	US	On	Off	Off	Blinking	On	On
4	ONLINE	On	Off	Off	Off	Off	Blinking
5	ETHERNET 1-4	On	On or Blinking	On or Blinking	On or Blinking	On or Blinking	On or Blinking
6	USB	On	On or Blinking	On or Blinking	On or Blinking	On or Blinking	On or Blinking
7	WIRELESS LINK	Off	On or Blinking	On or Blinking	On or Blinking	On or Blinking	On or Blinking
8	WIRELESS SETUP	Off	On or Blinking	On or Blinking	On or Blinking	On or Blinking	On or Blinking
9	MoCA	On	On or Blinking	On or Blinking	On or Blinking	On or Blinking	On or Blinking

Front Panel LED Status Indicators During Initial Power Up, Calibration, and Registration		
High Speed Data Registration (continued)		
Step:		7
Front Panel Indicator		Data Network Registration Complete
1	POWER	On
2	DS	On
3	US	On

4	ONLINE	On
5	ETHERNET 1-4	On or Blinking
6	USB	On or Blinking
7	WIRELESS LINK	On or Blinking
8	WIRELESS SETUP	Off
9	MoCA	On or Blinking

Normal Operations (AC Power applied)

The following chart illustrates the appearance of the residential gateway front panel LED status indicators during normal operations when AC power is applied to the gateway.

Front Panel LED Status Indicators During Normal Conditions		
Front Panel Indicator	Normal Operations	
1	POWER	On
2	DS	On
3	US	On
4	ONLINE	On
5	ETHERNET 1 - 4	<ul style="list-style-type: none"> ■ On - When a single device is connected to the Ethernet port and no data is being sent to or from the modem ■ Blinks - When only one Ethernet device is connected and data is being transferred between the consumer premise equipment (CPE) and the wireless home gateway ■ Off - When no devices are connected to the Ethernet ports
6	USB	<ul style="list-style-type: none"> ■ On - When a single device is connected to the USB port and no data is being sent to or from the modem ■ Blinks - When only one USB device is connected and data is being transferred between the consumer premise equipment (CPE) and the wireless home gateway ■ Off - When no devices are connected to the USB ports
7	WIRELESS LINK	<ul style="list-style-type: none"> ■ On - When the wireless access point is enabled and operational ■ Blinks - When data is being transferred between the CPE and the wireless home gateway ■ Off - When the wireless access point is disabled by the user
8	WIRELESS SETUP	<ul style="list-style-type: none"> ■ Off - When wireless setup is not active ■ Blinks - When wireless setup is active to add new wireless clients on the wireless network

Front Panel LED Status Indicator Functions

9	MoCA	<ul style="list-style-type: none"> ■ On - When a MoCA-enabled device is detected and the MoCA is operational ■ Blinks - When data is being transferred over the MoCA connection ■ Off - When the MoCA is disabled by the user
---	------	--

Special Conditions

The following chart describes the appearance of the cable modem front panel LED status indicators during special conditions to show when you have been denied network access.

Front Panel LED Status Indicators During Special Conditions		
Front Panel Indicator	Network Access Denied	
1	POWER	Slow Blinking 1 time per second
2	DS	Slow Blinking 1 time per second
3	US	Slow Blinking 1 time per second
4	ONLINE	Slow Blinking 1 time per second
5	ETHERNET 1 - 4	Slow Blinking 1 time per second
6	USB	Slow Blinking 1 time per second
7	WIRELESS LINK	Slow Blinking 1 time per second
8	WIRELESS SETUP	Slow Blinking 1 time per second
9	MoCA	Slow Blinking 1 time per second

Notices

Trademarks

Cisco and the Cisco logo are trademarks or registered trademarks of Cisco and/or its affiliates in the U.S. and other countries. A listing of Cisco's trademarks can be found at www.cisco.com/go/trademarks. DOCSIS is a registered trademark of Cable Television Laboratories, Inc. EuroDOCSIS is a trademark of Cable Television Laboratories, Inc. MoCA is a trademark of the Multimedia over Coax Alliance. The Wi-Fi Protected Setup mark is a mark of the Wi-Fi Alliance. Wi-Fi Protected Setup is a trademark of the Wi-Fi Alliance.

Other third party trademarks mentioned are the property of their respective owners.

The use of the word partner does not imply a partnership relationship between Cisco and any other company. (1009R)

Disclaimer

Cisco Systems, Inc. assumes no responsibility for errors or omissions that may appear in this guide. We reserve the right to change this guide at any time without notice.

The maximum performance for wireless is derived from IEEE Standard 802.11 specifications. Actual performance can vary, including lower wireless network capacity, data throughput rate, range and coverage. Performance depends on many factors, conditions and variables, including distance from the access point, volume of network traffic, building materials and construction, operating system used, mix of wireless products used, interference and other adverse conditions.

Documentation Copyright Notice

Information in this document is subject to change without notice. No part of this document may be reproduced in any form without the express written permission of Cisco Systems, Inc.

Software and Firmware Use

The software described in this document is protected by copyright law and furnished to you under a license agreement. You may only use or copy this software in accordance with the terms of your license agreement.

The firmware in this equipment is protected by copyright law. You may only use the firmware in the equipment in which it is provided. Any reproduction or distribution of this firmware, or any portion of it, without our express written consent is prohibited.

For Information

For Information

If You Have Questions

If you have technical questions, call Cisco Services for assistance. Follow the menu options to speak with a service engineer.



Cisco Systems, Inc.
5030 Sugarloaf Parkway, Box 465447
Lawrenceville, GA 30042

678 277-1120
800 722-2009
www.cisco.com

This document includes various trademarks of Cisco Systems, Inc. Please see the Notices section of this document for a list of Cisco Systems, Inc., trademarks used in this document. Product and service availability are subject to change without notice.

© 2011 Cisco and/or its affiliates. All rights reserved.
September 2011 Printed in USA

Part Number 4025083 Rev A